

POWERSTATION



Model P2 User Guide



POWERSTATION

Model P2 User Guide

***Computer Technology Corporation
50 W. TechneCenter Drive, Milford, Ohio 45150***

***Phone: 513-831-2340
Technical Support: 513-248-1714***

A3-05425-101

Copyright and Trademark Notice

Copyright © 1998 by Computer Technology Corporation. All rights reserved. No part of this publication may be reproduced, transmitted, transcribed, stored in a retrieval system, in any form or by any means, mechanical, photocopying, recording or otherwise, without the prior written consent of Computer Technology Corporation.

While every precaution has been taken in the preparation of this manual, Computer Technology Corporation and the author assume no responsibility for errors or omissions. Neither is any liability assumed for damages resulting from the use of the information contained herein. All product and company names are trademarks of their respective companies and licenses.

Product Warranty Information

Computer Technology Corporation provides top quality products through rigid testing and the highest quality control standards. However, should a problem occur with your hardware or with the software protection key, CTC's standard product warranty covers these items for 15 months from the date of shipment from CTC. Exceptions appear below:

- PowerStation backlight bulbs have a 90-day warranty. Push button lamps are not covered under warranty.
- Third-party products, such as PCMCIA cards, carry the manufacturer's specified warranty.
- For all displays, image retention (burn-in) is not covered by warranty.
- Software revisions that occur within 60 days after purchase are available under warranty upon request. Please review the Interact License Agreement for additional software warranty information.

Should you have any questions about your application or need technical assistance, please call CTC's Product Technical Support department at 513-248-1714, 8:00am to 5:00pm, EST. You may call this same number after hours for emergency assistance. See *Customer Support Services* on page 7 of this manual for more information about CTC's support products and services.

Table of Contents

Chapter 1 Getting Started	1
Documentation Components	2
Documentation Standards	3
ISO Symbols	3
Software Components	4
Important Concepts	5
Before You Begin	5
Configure the PowerStation	5
Develop an Interact Application	6
Create an application	6
Test the application	6
Download the application	6
Install the PowerStation	6
Customer Support Services	7
Product Technical Support	7
Technical Support Products	8
Product Support Program	8
Chapter 2 Understanding the PowerStation	9
Specifications	10
Physical Specifications	10
Environmental Specifications	11
Electrical Specifications	12
Testing Specifications	13
Faceplate Chemical Resistance	13
Available Connectors	14
Serial Ports	15
COM1 pinouts	15
COM2 pinouts	16

Table of Contents

Cable diagrams	17
Connecting to a PC	17
Connecting a serial mouse.	18
Connecting to a serial printer	18
CRT Port.	19
Parallel Port	20
Connecting to a parallel printer	20
Keyboard Port.	21
Ethernet Port	21
Compact Flash	22
Drive Definitions and Memory Map	23
PowerStation Memory Map	23
Memory Guidelines.	24
Jumper Settings	24
Using a Touch Screen with Interact	27
Interact Startup Directory	27
Chapter 3 Using the PowerStation Shell Utility.	29
Introduction.	30
Powering Up the PowerStation.	30
Selecting Screen Options.	31
Menu Definitions.	32
Main Menu	32
Help On Shell	33
Configuration Settings	34
Set Hardware	34
Set Path	37
Touch Screen Calibration.	38

Table of Contents

System Information	39
Port Usage	40
Memory Map	40
Go To Interact	41
Utility Menu	41
Security Key	41
Dir.	42
Exit Shell	42
System Tests	43
Keyboard Test	43
DOS Shell	43
Reinstalling the Shell Software	44
Recalibrating the Touch Screen	46
Chapter 4 Installing the PowerStation	49
Selecting a Location	50
Class I, Division II Guidelines	50
Environmental Guidelines	50
Faceplate Considerations	50
Electrical Guidelines	51
Temperature Guidelines	51
Enclosure Guidelines	51
AC Power Guidelines	51
Creating the Cutout	52
Preparing to Use an AC Power Supply	52
Installing the Unit	53
Mounting the Unit	53
Mounting the AC Power Supply	53
Powering Up the Unit	54

Table of Contents

Chapter 5 Maintaining and Troubleshooting the PowerStation	55
Reformatting the Compact Flash	56
Modifying the AUTOEXEC.BAT File.	59
Configuring the Touch Screen Drivers	60
Configuring the Ethernet Interface	62
Performing Internal Maintenance/Upgrades.	63
Electrostatic Discharge Precautions.	63
Disassembling the PowerStation	64
Adding and Replacing DRAM.	65
Removing a DRAM module	65
Installing a DRAM module	66
Adding PC/104 Modules.	66
Safety Precautions.	67
Address Considerations.	67
IRQ Considerations	67
Changing the Jumper Settings	68
JP1 Ethernet default jumper.	68
JP6 Touch screen IRQ jumpers.	68
COM2 jumpers.	71
Reassembling the PowerStation	71
Cleaning the Touch Screen	72
Resolving Common Problems	72
Resolving Problems When Powering the Unit	74
Resolving AUTOEXEC.BAT and CONFIG.SYS problems.	74
Resolving other problems during power up	75

Table of Contents

Resolving Problems After Powering the Unit	78
Resolving problems with the touch screen.	78
Resolving other problems after power up	79
Resolving problems with Interact	81
Appendix A P2 PowerStation Dimensional Drawings . . .	85
Side View	85
Bottom View	86
Index	87

Table of Contents

Getting Started

Thank you for purchasing a P2 PowerStation. The PowerStation is a rugged, compact PC that is designed to be used as an industrial operator interface. You will find that the PowerStation has been built to provide years of trouble-free operation even in the harshest environments.

The PowerStation features a durable touch screen, an all-in-one PC board that includes a parallel port, two serial ports, and an Ethernet port. The PowerStation's PC architecture allows you to run CTC's Interact software.

Please take a few minutes to review this manual and all other documentation included with the PowerStation before operating the unit.

Chapter Contents

<i>Documentation Components</i>	2
<i>Documentation Standards</i>	3
<i>Software Components</i>	4
<i>Important Concepts</i>	5
<i>Customer Support Services</i>	7

Documentation Components

The P2 PowerStation documentation set contains all the information you need to configure, install, and use the PowerStation. It also contains information about the PowerStation Shell Utility and the Interact Project Manager. The P2 PowerStation documentation set is described below.

Release Notes—This document is provided whenever there is important information about the PowerStation that does not appear in this manual. Be sure to read the release notes before operating the unit.

P2 PowerStation User Guide—This document is the document you are reading. It provides detailed information about the PowerStation and describes how to configure, install, and use the unit. It also contains information about the PowerStation Shell Utility. Please read this manual in its entirety prior to operating the unit.

CPU Manual—This document is the manual provided by the manufacturer of the CPU board found in your PowerStation. Please familiarize yourself with this manual prior to operating the unit.

PowerStation Template—This document is a full-size template of the PowerStation you can use to prepare the location where you want to install the unit.

IPM User Guide—This document describes how to install and use the Interact Project Manager to download Interact projects from a PC to the PowerStation. This manual is only included with Interact systems.

Documentation Standards

As you read this manual, you will notice that the following documentation standards have been followed.

1. Important terms are shown in **bold**.
2. Text to be entered from the keyboard is shown in `Courier` font.
3. Buttons, menu titles, and keyboard keys are shown in Initial Caps.
4. Indented paragraphs denote one of the following:
 - **Note**—Describes alternative approaches or issues you should be aware of while using a particular function.
 - **Important**—Contains information that needs particular attention while reading the text. Follow this information to save development time and/or minimize problems.
 - **Warning**—Contains information on safety issues. Follow this information to prevent equipment damage or personal injury.

ISO Symbols



This symbol is the International Standards Organization (ISO) symbol for Caution (ISO 3864 No. B.3.1). This symbol denotes information that could affect operation of the PowerStation if not properly followed.



This symbol is the ISO symbol for Caution—risk of electrical shock (ISO 3864 No B.3.6). This symbol denotes information that could cause personal injury from electrical shock or damage to equipment if not properly followed.

Software Components

CTC pre-loads each PowerStation with the operating system, utilities, and Interact software, so you can run the PowerStation immediately upon its arrival at your facility. CTC also provides source disks for this software should you need to reinstall it at a later time. This section describes each disk and its use.

Interact Project Manager KA-82228: This disk contains the program files for the Interact Project Manager (IPM) utility. You must install IPM from this disk to your development system after installing Interact in order to download projects to the PowerStation. Refer to the IPM User Guide for installation and usage instructions.

PowerStation Shell Install Disk KA-72451: This disk contains the program files for the PowerStation Shell, which are already installed on your unit. The PowerStation Shell is used to configure the PowerStation and receive Interact project files from a development system. This disk also contains backup copies of the touch screen driver, Ethernet drivers, VESA VGA driver, etc.

Important All shell install disks prior to KA-72451-202 contain software for a bus touchscreen driver - the driver used on earlier models of the P2. The disks from KA 72451-202 and later contain software for a serial touchscreen driver, used in the current model of the P2 and later. Be sure to verify which type of driver your P2 PowerStation uses before choosing a shell install disk.

ROM-DOS 6.22 and Utilities Disk KA-72579: This disk contains the ROM-DOS operating system that has been installed on your unit. This disk also contains copies of all the ROM-DOS utilities. Some of these utilities have been installed on your system already, but you can use this disk to reinstall ROM-DOS or add additional utilities to your system.

Important Concepts

Now that you have opened the PowerStation package, you are ready to unpack the unit, configure it, and install it in a permanent location. This section provides an overview of the steps that are discussed in detail throughout the remainder of this manual.

Before You Begin

Before you begin operating the PowerStation, please complete the following steps:

1. Unpack the PowerStation and verify that you have received all the components you ordered. The components that were shipped with the unit are listed on the packing list included in the PowerStation carton.
2. Review the Product Support Program (PSP) flier included with Interact. This flier outlines the program and its pricing. New customers automatically receive a free 60-day membership in the program.
3. Back up the CTC software disks that came with your unit using the Windows® File Manager/Explorer or the MS-DOS® Diskcopy command.
4. Read the PowerStation Release Notes. This document provides important information about the PowerStation that does not appear in this manual.

Configure the PowerStation

Once you have unpacked the PowerStation and completed the steps listed in the previous section, you are ready to power up the PowerStation for the first time and configure the system defaults. Detailed information on configuring the PowerStation is described in Chapters 3 and 4.

Develop an Interact Application

The P2 PowerStation is designed to run applications you create using CTC's Interact application development software. The P2 PowerStation is a runtime-only system, which means you must develop applications on a PC and download them to the PowerStation.

Important Throughout this manual all references to 'development PC' or 'development system' refer to the computer you use to develop Interact applications.

Create an application

If you are new to Interact, read the Interact Getting Started Manual to learn more about the software. This manual includes example applications you can modify and run, providing hands-on experience with each Interact module.

Test the application

When you finish developing an application, you should test it prior to running it in a production environment. If you develop an application on a PC using Interact, you can use Interact's Test Mode to test the application before downloading it to the PowerStation.

Download the application

When you finish developing an application on a PC using Interact, you can use the Interact Project Manager (IPM) to assign the application to a project and download it to the PowerStation. Refer to the IPM User Guide for more information about downloading projects to the PowerStation.

Install the PowerStation

When you finish unpacking the PowerStation and developing an application, you are ready to install the unit in a permanent location. Refer to Chapter 4 for complete installation instructions.

Customer Support Services

CTC welcomes your thoughts and suggestions on our products and services. You can contact CTC by telephone, email, or fax. You can also visit CTC on the World Wide Web to learn the latest about CTC hardware, software, and customer support services.

Telephone: 513-831-2340

Fax: 513-831-5042

E-mail: sales@ctcusa.com or support@ctcusa.com

World Wide Web: <http://www.ctcusa.com>

CTC recognizes that every customer and every application has different support needs, so CTC offers a variety of support services designed to meet those needs. CTC offers three types of customer support services: Product Technical Support, Technical Support Products, and the Product Support Program.

Product Technical Support

The Product Technical Support department welcomes any question that might arise as you develop or run your applications. We offer complimentary support for any customer, whether you are an end-user, original equipment manufacturer (OEM), system integrator, or distributor.

If you have a question about the PowerStation, be sure to complete the following steps:

1. Check the release notes shipped with the unit. These notes provide important information about the PowerStation.
2. Consult the PowerStation documentation and other printed materials included with the PowerStation.
3. Review Chapter 5 of this manual, *Maintaining and Troubleshooting the PowerStation*.

If you cannot find a solution using one of the above sources, contact CTC's Product Technical Support department at 513-248-1714, 8:00am to 5:00pm, EST. You may call this same number after hours for emergency assistance.

Technical Support Products

Our Technical Support Products department provides service in two areas: training and consulting. CTC offers training on all our products either at CTC in our state-of-the-art training center or at your site. You can learn how to write custom interfaces, develop specialized applications, and implement your complete, operator interface application. You can contact the Training Coordinator by phone at 1-800-233-3329 or by email at training@ctcusa.com.

CTC offers consulting services through our Professional Consulting Services (PCS) group. Our PCS group can build your application from the ground up by writing custom, communications drivers or designing special modules to perform functions unique to your application. Our team of specialists is flexible, so they can create a project development schedule that meets your needs. You can contact the PCS Coordinator by phone at 1-800-233-3329 or by email at pcs@ctcusa.com.

Product Support Program

The Product Support Program (PSP) is designed to keep you up-to-date with the current version of Interact software. The PSP consists of a renewable, one-year membership that provides you with free upgrades, utilities, automatic notification of software updates, and other valuable tools for Interact. Single-user, site, and corporate licenses are available. The PSP is an easy, cost-effective way to automatically receive the most recent Interact software and the associated utilities. You can contact the PSP Coordinator by phone at 1-800-233-3329 or by email at psp@ctcusa.com.

Understanding the PowerStation

The P2 PowerStation is designed to give you an operator interface solution that is powerful, cost-effective, and very easy to use. The PowerStation family of workstations is available in a variety of configurations to fit the functionality and cost requirements of your application.

In this chapter, you will learn about the PowerStations' drive definitions and memory maps, connectors, and other important specifications.

Chapter Contents

<i>Specifications</i>	10
<i>Available Connectors</i>	14
<i>Drive Definitions and Memory Map</i>	23
<i>Jumper Settings</i>	24
<i>Using a Touch Screen with Interact</i>	27
<i>Interact Startup Directory</i>	27

Specifications

This section lists and describes some important specifications relating to the PowerStation. Please familiarize yourself with these specifications prior to operating the PowerStation.

Physical Specifications

Physical specifications include the PowerStation's physical characteristics and compatible hardware devices. Refer to the table below:

Category	Specifications
CPUs	<ul style="list-style-type: none"> • PCA-6135 386SX, 40MHz • PCA-6145L 5x86, 133MHz
Displays	<ul style="list-style-type: none"> • Monochrome LCD, 640x480 VGA, 16 shades of gray • Color STN, 640x480 VGA, 256 colors • Color TFT, 640x480 VGA, 256 colors
Memory	4 or 8MB, Fast Page Mode, 72-pin SIMM
Storage	4, 10, 20, 40MB solid state flash drive (field expandable and replaceable)
I/O Ports	<ul style="list-style-type: none"> • 1 9-pin RS232 (non-isolated) • 1 9-pin RS232/422/485 (non-isolated) • 1 25-pin IBM parallel • 1 PS/2 keyboard • 1 RJ45 Ethernet (Novell NE-2000 compatible, on-board, 10Base-T interface)
PC/104 Bus Extension	16-bit, +/-5V, +/-12V
Dimensions (H x W x D)	11.0" (280mm) x 13.8" (350mm) x 3.5" (89mm)
Weight	12.6 lbs. (5.6 Kg)

Environmental Specifications

The PowerStation conforms to the environmental specifications listed in the table below:

Category	Specifications
Operating Temperature:	32 to 122°F (0 to 50°C) ambient air temperature at air inlets
Bulb Life:	<ul style="list-style-type: none"> • Monochrome LCD - 10,000 hours • Color STN - 25,000 hours • Color TFT - 25,000 hours
Relative Humidity:	5% to 95% non-condensing
Altitude:	-200ft. to 10,000ft. (-60.96m to 3,048m)
Shock Rating:	<ul style="list-style-type: none"> • 10g peak, 11ms (operating) • 30g peak, 11ms (non-operating)
Operating Vibration:	0.35mm 10 to 18Hz, 1.0g from 18 to 150Hz
Faceplate Designed For:	NEMA 4/4X (IP65 European Std.) Environ.

Important Limit the PowerStation's exposure to adverse conditions such as dust, oil, moisture, and corrosive vapors to minimize maintenance and repair costs.

Remember that the temperature outside a protective enclosure is generally lower than the internal temperature. Thus, if the PowerStation is operating inside an enclosure at temperature levels above the maximum ambient temperature, you will need to cool the enclosure.

Electrical Specifications

The PowerStation's electrical specifications appear in the table below:

Category	Specifications
Input Voltage	20–36 VDC
Power Consumption	42W maximum (54W maximum with PC/104)
Fuse Type	3.15A, 250 VAC Littelfuse 216.315 or equivalent
PC/104 Power Availability	1.5A@5V, 0.2A@12V; 75mA@-5V, 75mA@-12V

Important The PowerStation's power supply automatically detects the input voltage level and adjusts accordingly. However, always use reliable sources of power and isolate all communication cables from AC power lines to enhance noise immunity.

If possible, locate the PowerStation away from machinery that produces intense electrical noise (arc welders, etc.). Otherwise, isolate the input power to the PowerStation from the equipment generating electrical noise.

Special note for units with replaceable lithium batteries



Danger of explosion if battery is incorrectly replaced. Replace only with the same or equivalent type recommended by the manufacturer. Dispose of used batteries according to the manufacturer's instructions.

Testing Specifications

The PowerStation conforms to the testing specifications listed below:

Testing Criteria	Classification
Showering arc	NEMA showering arc
Surge withstanding capacitance	IEEE 472-1974
ESD requirements	IEC 801-2
Operating temperature	IEC 68-2-1
Electrical fast transient	IEC 801-4
European Harmonized EAC Standards	EN50082-2, EN55011
Operating vibration	IEC 68-2-6
Mechanical shock	IEC 68-2-27
Random vibration	MIL-STD-810D

Faceplate Chemical Resistance

The faceplate of the PowerStation can resist the chemicals listed in the table below with no visible effect.

Faceplate Chemical Resistance		
Acetone	Sulfuric Acid 10%	Motor Oil
MEK	Hydrochloric Acid 10%	Gasoline
Toluene	Acetic Acid 10%	Machine Oil
Methylene Chloride	Phosphoric Acid	Salad Oil
Isopropyl Alcohol	Sodium Hydroxide 10%	Silicone
Xylene	Carbon Tetrachloride	Silicone Grease G31
Hexane	Potassium Hydroxide	Kerosene
Butyl Cellosolve	Ammonia Water 10%	Gas Oil
Cyclohexanone	Sodium Chloride 26%	Silicone Oil
Trichloroethylene	Zinc Chloride 81%	Engine Oil
Ethanol	Cottonseed Oil	Cleanser
Methanol	Glycerin	
Nitric Acid 10%	Grease	

Available Connectors

All PowerStation surfaces exposed to the outside of your enclosure are resistive to the following chemicals:

- Commercial glass cleaners
- Ammonia (10% dilute solution)
- Motor Oil
- Hydraulic fluid
- Diesel fuel
- Gasoline (leaded, unleaded)
- Silicone based lubricant
- Alcohol (ethyl, methyl)
- Automatic transmission fluid

Important Sustained exposure to brake fluid or Gunk[®] brand degreaser can cause damage to monitor materials.

Available Connectors

The PowerStation includes the same ports found on most PC's. All PowerStations have two serial ports, one parallel port, a video port, an Ethernet port, and a PS/2-style keyboard port:

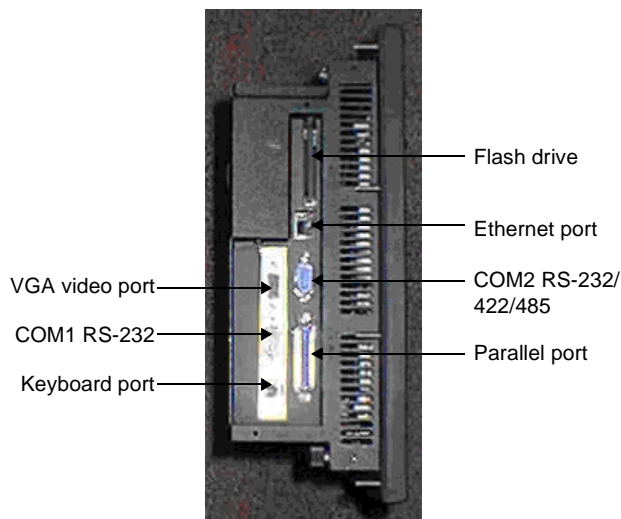

Serial Ports

The PowerStation has two serial ports you can use to communicate with external devices. These ports support baud rates of up to 115 Kbaud. COM1 supports RS-232, while COM2 supports RS-232, RS-422, and RS-485 communication standards.

The communication standard you select for COM2 depends on the distance between the PowerStation and the controller as well as the communication standards that the controller supports. Use a standard DB9 connector for communicating with this port.

Note If you are using RS-232 communications, the length of the serial cable should not exceed 50 feet (15 meters).

RS-422 and RS-485 communications offer greater noise immunity than RS-232. These standards increase the maximum cable length to 4000 feet (1200 meters).

RS-422 communications are full-duplex (can send and receive simultaneously) while RS-485 communications are half-duplex (can only send or receive at one time).

For either configuration, be careful not to connect any wires to unused connector pins. Information on the specific connection required for the Interact driver you use is located in the Help file associated with the driver.

COM1 pinouts

If you need to make a cable for communicating with COM1, the following table shows the pinouts and signal information for this port:

Pin #	Signal Name
1	DCD, data carrier detect
2	RXD, received data
3	TXD, transmitted data
4	DTR, data terminal ready
5	Signal ground
6	DSR
7	RTS, request to send
8	CTS, clear to send
9	RI

COM2 pinouts

If you need to make a cable for communicating with COM2, the following table shows the pinouts and signal information for this port. COM2 is set to the RS-485 protocol by default. To change COM2 to the RS-232 or RS-422 protocols, you must change the COM2 jumper settings. See *COM2 jumpers* on page 71 for these procedures.

Pin#	RS-232 Signal	RS-422 Signal	RS-485 Signal
1	DCD, data carrier detect	TXD-, transmitted data -	TXD-, transmitted data -
2	RXD, received data	TXD+, transmitted data +	TXD+, transmitted data +
3	TXD, transmitted data	RXD+, received data +	RXD+, received data +
4	DTR, data terminal ready	RXD-, received data -	RXD-, received data -
5	Signal ground	Signal ground	Signal ground
6	DSR, data set ready	DSR, data set ready	DSR, data set ready
7	RTS, request to send	RTS, request to send	RTS, request to send
8	CTS, clear to send	CTS, clear to send	CTS, clear to send
9	RI	RI	RI

Cable diagrams

The following graphics represent the pinouts and cable diagrams required for communicating with COM1 or COM2 using the RS-232 protocol. Also shown are cable diagrams for communicating with COM2 using the RS-422 or RS-485 protocols.

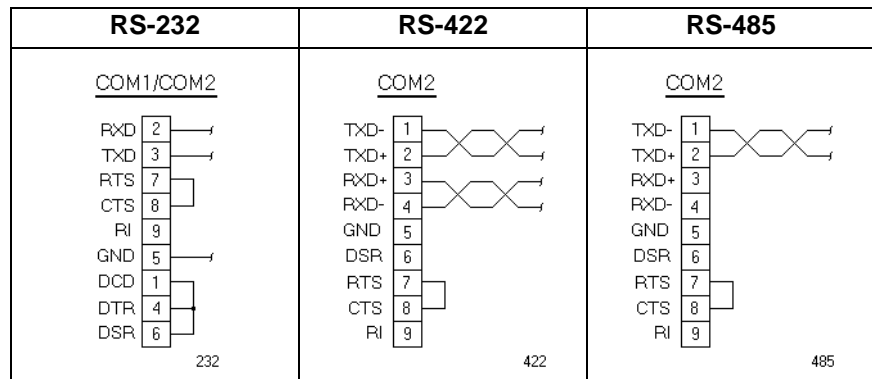

Important Be careful not to connect any wires to unused connector pins.

Connecting to a PC

To transfer files from a PC to the PowerStation, connect a serial cable with a null modem to an available serial port on the PC. Connect the other end of the cable to the serial port on the PowerStation. If you need to construct your own cables, refer to the figures below.

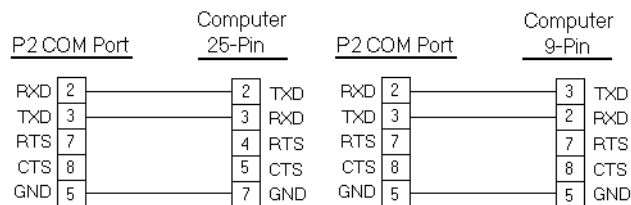

Connecting a serial mouse

If you need to connect a mouse to the PowerStation, you must use a serial mouse connected to either COM1 or COM2. If you use COM2, you may need to reconfigure this port to use the RS-232 protocol (see page 71). Follow these steps to configure the PowerStation to use a serial mouse:

1. If you will be using COM2, verify that it is configured for RS-232 communications. See *COM2 jumpers* on page 71 to change the communications protocol for this port.
2. Connect the serial mouse to the port you configured, and reboot the PowerStation.

Connecting to a serial printer

If you need to connect the PowerStation to a serial printer, you will need to change the mode settings for one of the serial ports to match those of your printer. The easiest way to change these settings is to use MODE.COM. MODE.COM can modify the following options:

baud: 110, 150, 300, 600, 1200, 2400, 4800, 9600

parity: N - none, O - odd, E - even

databits: either 7 or 8

stopbits: either 1 or 2

To use MODE.COM, complete the following steps:

1. Create a new AUTOEXEC.BAT file with the following line:
`MODE COM#:baud,parity,databits,stopbits`
2. Copy this file into the \STARTUP directory of the IPM project on your development system.
Note CTC installs MODE.COM on the PowerStation's flash drive and includes a copy on the ROM-DOS 6.22 and Utilities Disk.
3. Run Interact Project Manger (IPM) and download the project that contains AUTOEXEC.BAT and MODE.COM from your development system to the PowerStation.

During the download, IPM transfers the AUTOEXEC.BAT file you created in step 1 into the \STARTUP directory specified by the INTERACT_STARTUP environment variable. This environment variable resides in the PowerStation's AUTOEXEC.BAT.

When IPM finishes the download, the PowerStation automatically reboots, and MODE.COM configures the COM port to the required baud rate. For example, if you are communicating at 9600, NONE, 8, and 1, use:

```
MODE COM1: 9600,N,8,1
```

Note To print to a port configured for downloading, you must disable downloading for that port, and reboot the PowerStation. Rebooting the PowerStation allows MODE.COM to reset the communication settings for that port. Use the DOWNLOAD ENABLE command on the SETTINGS menu of the Shell to disable downloading.

4. Use the following diagram as a reference when connecting a serial printer to the PowerStation.

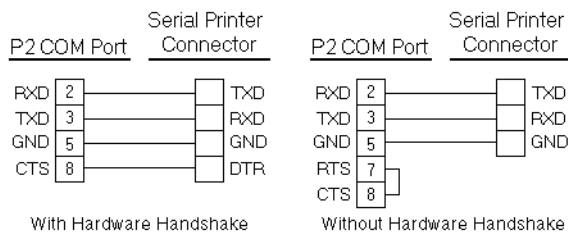

CRT Port

The CRT port has been disabled because the timing requirements of PowerStation's LCD and STN displays differ from those of CRT displays. The PowerStation has a CRT port that allows you to use an external SVGA monitor in place of the flat-panel display. On TFT units, this port allows you to use an external monitor and the flat-panel display simultaneously. This port supports monochrome and high resolution color displays. Refer to the CPU manual for the CRT port's pinout information.

Note The maximum resolution of the PowerStation flat-panel display is 640 x 480, but the CRT port can support up to 1024 x 768.

Parallel Port

The PowerStation parallel port (LPT1) pinout is identical to the standard IBM parallel printer port. The LPT1 connector pinout is shown in the table below.

Pin #	Signal Name
1	STROBE
2	DATA 0
3	DATA 1
4	DATA 2
5	DATA 3
6	DATA 4
7	DATA 5
8	DATA 6
9	DATA 7
10	- ACKNOWLEDGE
11	BUSY
12	PAPER EMPTY
13	+ SELECT
14	- AUTO FEED
15	- ERROR
16	- INIT PRINTER
17	- SELECT INPUT
18-25	GROUND

Connecting to a parallel printer

The PowerStation can interface to any parallel printer designed for use with IBM PC compatible computers. Connect a printer to the port marked LPT1 using a standard IBM PC parallel cable.

Keyboard Port

The PowerStation's CPU board includes a mini-DIN keyboard port. This port can accept input from keyboards that have a PS/2 connector. This port can also accept input from IBM AT-compatible keyboards, including 84-key standard keyboards and 101-key enhanced keyboards, using the supplied keyboard adapter cable.

Important Do NOT connect a PS/2 mouse to the keyboard port on units with the PCA-6135 386 CPU card. This port is only intended to be used as a keyboard port. If you need to connect a mouse to the PowerStation, you must use a serial mouse. See *Connecting a serial mouse* on page 18 for more information.

Note PC/XT keyboards will NOT function with the PowerStation.

Ethernet Port

The PowerStation has an Ethernet RJ-45 port that allows you to connect the PowerStation to a Local Area Network. This port is software compatible with the NE-2000 protocol and supports all major network operating systems.

Pin#	Signal
1	TX+
2	TX-
3	RX+
4	N/C
5	N/C
6	RX-
7	N/C
8	N/C

Compact Flash

The PowerStation has a Compact Flash (CF) card that is like a removable hard drive. It provides non-volatile memory storage. The CF is often used as a supplement to or a replacement for hard drives because it is well-suited for environments where the PowerStation may be vibrated or shaken. The CF card is recognized as drive C. While the CF is removable, it cannot be removed while the PowerStation is running because it is used as an IDE drive.

Drive Definitions and Memory Map

This section provides information about the PowerStation's drive definitions. This section also includes a graphical illustration of the PowerStation's memory map.

Drive Letter	Type	Size	Usage
C:	Compact Flash (CF) Card (Read/Write)	4, 10, 20, or 40MB	System boot drive and Project disk. Stores the project, Interact, applications, etc. Download files to this drive, but do not log data to this drive because it can only accept a limited number of writes.

PowerStation Memory Map

The following graphic illustrates how the PowerStation allocates conventional memory and extended memory. The range of address references is listed next to each device.

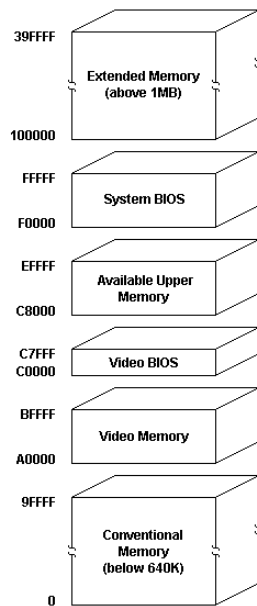

Memory Guidelines

Refer to the memory guidelines listed below when you develop projects. The following table lists guidelines to follow concerning the use and capacity of memory used for runtime and development systems.

Memory Type	Runtime
System DRAM	4 MB system memory runs APM, PTM, and AMM runtime modules and 2 drivers. Extra modules require more memory.
Compact Flash (CF) Card	4 MB flash memory can store APM, PTM, AMM, plus 4 additional runtime modules, 2 drivers, and approx. 30 screens. Extra modules require more storage (4 modules/MB). Do not use for data logging.

Jumper Settings

Like most PCs, the PowerStation uses jumpers to set addresses and enable or disable various functions of the system. The PowerStation's Ethernet/Power Supply board has three jumpers that are user-configurable. These jumpers are shown below. For more information about changing the jumper settings see *Performing Internal Maintenance/Upgrades* on page 63.

JP1

This jumper is used to restore the Ethernet configuration to IRQ 10 and I/O 240H. This jumper is located near the IDE hard drive connector on the Ethernet/Power Supply board. To restore the Ethernet configuration to IRQ 10 and I/O 240H, install a clip on this jumper.

JP6

This set of jumpers is used to configure the hardware IRQ for the touch screen. The touch screen IRQ jumpers are located at the lower left corner of the Ethernet/Power Supply board, just beneath the CPU card. CTC Parker configures these jumpers to use IRQ 11.

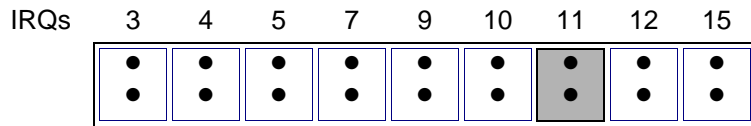

To change these jumpers, you may need to remove the CPU card. For more information about changing these jumpers, see *Performing Internal Maintenance/Upgrades* on page 63.

JP7

This set of jumpers configures the address for the touch screen. It is configured by turning “on” or “off” the jumpers A and B. The chart below demonstrates the on/off combinations for each of the ports.

I/O Address	A	B
COM1 (3F8h)	off	off
COM2 (2F8h)	off	on
COM3 (3E8h)	on	off
COM4 (2E8h)	on	on

The touch screen jumpers are set to I/O address COM3 (3E8h) with the A jumper “on” and the B jumper “off” by default. The touch screen could also be configured to the COM4 (2E8h) address by turning the A and B jumpers “on,” as demonstrated below.

Important After changing the jumper settings for the touch screen I/O address, you must change the touch screen configuration drivers for the changes to be implemented. See *Configuring the Touch Screen Drivers* on page 60 for more information

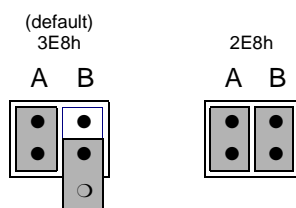

Note The clip for the “off” jumper can be completely removed or placed as in the figure above.

COM2 jumpers

CTC configures the COM2 serial port for RS-485 communications; however, you can configure this port to communicate using RS-232 or RS-422 by changing the jumper settings on the CPU card.

To configure COM2 to use RS-232, move the clip to the RS-232 position and move the COM2 cable from RS-422/485 connector to the RS-232 connector. For more information about changing these jumpers, see *Performing Internal Maintenance/Upgrades* on page 63, or refer to the CPU manual that came with your unit.

Using a Touch Screen with Interact

If you are using a touch screen with Interact and your application uses PTM Slide input tools, be sure to select the Arrow cursor type using the Interact Settings command in Application Manager. When you select the Arrow cursor type, touching the Slide tool selects the tool, and moving your finger over the touch screen moves the slide knob.

If you use the Box Cursor type, the slide knob immediately moves to the location where you press the tool. For example, if the knob is currently positioned at 100 and you press the touch screen at a value of 800, the knob immediately moves to 800 and writes this value to the controller.

Warning Using the Box Cursor with a touch screen and an application that uses Slide input tools may cause you to inadvertently select input values. If your application requires you to use a cursor, select the Arrow cursor type instead.

Interact Startup Directory

The INTERACT_STARTUP environment variable determines where the Startup files will be placed (i.e., C:\STARTUP). When a download occurs, all existing files in the Startup directory are erased, which is why Startup files are saved in C:\STARTUP, rather than in the root directory. The INTERACT_STARTUP environment variable is set in the AUTOEXEC.BAT, in case you want to change it.

Using the PowerStation Shell Utility

Now that you are familiar with some of the PowerStation's features, it's time to configure your system. This chapter will show you how to use the PowerStation Shell Utility (also referred to throughout this manual as "the Shell") to configure your system. The PowerStation Shell Utility is a program that runs on the PowerStation and is used to configure the unit and enable various features for using the PowerStation with Interact.

Chapter Contents

<i>Introduction</i>	30
<i>Powering Up the PowerStation</i>	30
<i>Selecting Screen Options</i>	31
<i>Menu Definitions</i>	32
<i>Reinstalling the Shell Software</i>	44
<i>Recalibrating the Touch Screen</i>	46

Introduction

Prior to using the PowerStation you should understand the features available with the PowerStation Shell Utility. The PowerStation Shell comes pre-installed on your system. However, if you need to reinstall the Shell software or the touch screen drivers, you can use the PowerStation Shell Setup disk. See *Reinstalling the Shell Software* on page 44 for more information.

When you first power up the PowerStation, the Shell Main Menu appears. The Shell Main Menu contains information about the project currently loaded on the PowerStation. If no project exists, these settings will be set to NONE. See *Main Menu* on page 32 for more information about the Shell Main Menu.

Powering Up the PowerStation

Once you have unpacked the PowerStation, you can power it up for the first time. Complete the following steps to power up the PowerStation:

1. Verify that the power switch is in the OFF position.
2. Connect the PowerStation to a 20-36VDC power source.

Note If you are using an external AC power supply, you must first connect the power supply to the DC output on the back of the PowerStation; then, connect the power input to a 90 to 250VAC power source.

3. Move the power switch to the ON position.

Selecting Screen Options

To select screen options, touch the menu item or move the cursor over the menu item you want to select and press the left mouse button. A submenu of options appears that you can change for this menu item. Upon selecting a submenu, you can return to the previous menu by:

- pressing the PREVIOUS MENU button on the screen
- touching outside the pop-up menu area
- pressing the left mouse button outside the pop-up menu area
- pressing the Esc key on the keyboard
- pressing the right mouse button
- pressing the Cancel button on units with function keys.

Throughout the remainder of this section it is assumed that you are using a keyboard and mouse.

Menu Definitions

This section provides a description of each item on the Shell Main Menu and the function of each selection button.

Main Menu

When you power up the PowerStation, the Shell performs an internal check of the configuration settings for the unit and displays the Shell Main Menu as shown below.



The following items appear on the Shell Main Menu:

Name	Description
PROJECT NAME	Displays the name of the currently loaded project.
INTERACT TYPE	Displays whether Interact software is installed on your PowerStation. Will display "UNKNOWN," or "EXTENDED RUNTIME."
MODULES	Displays the abbreviated name of each Interact module installed with the application you are using on the PowerStation. For example, if the Panel Toolkit Module is loaded, the acronym "PTM" is displayed.
DRIVERS	Displays the abbreviated name of each Interact driver installed with the application you are using on the PowerStation. For example, if the Siemens Programming Port driver is loaded, the acronym 'SIEMPP' is displayed.

Name	Description
APPLICA-TIONS	Displays a list of applications in the project that were created in Interact or copied from another project.

Help On Shell

Select the HELP ON SHELL button to enter the Shell help system. To request help on a menu button or option, move the cursor to the function and press the F1 key on the keyboard. A page of text is displayed similar to the one below.

```

[ HELP ]
HELP ON POWERSTATION SHELL                               Page 1

                POWERSTATION SHELL
                Copyright (c) 1998
                Computer Technology Corporation
                All Rights Reserved

To exit the help screen, or to exit a menu and return to
the previous menu, do one of the following:
- press the [Esc] key on the keyboard
- click outside of the help window or menu
- press the right mouse button

PgDn

```

To exit the help, press the Esc key on the keyboard, press the right mouse button, or click outside the Help box. If more than one page of information is available for an item, press the PgUp or PgDn buttons.

Configuration Settings

Select the CONFIG SETTINGS button to change the PowerStation hardware settings. Once assignments have been made, they are stored in the PWR.CFG file on drive C.

Important The hardware configuration settings stored in the PWR.CFG file are saved on drive C (flash disk). Do not delete this file, or you will have to reset the hardware configuration.

Set Hardware

Select the SET HARDWARE button to change or modify the PowerStation setup. For most options, just select the item to toggle the selection. Other options display a submenu with additional selections. Any changes you make on this menu do not take effect until you exit this menu.

POWER ON OPERATION

Use the POWER ON OPERATION option to select whether Interact or the Shell will run after the PowerStation is turned on. The selections are:

- RUN INTERACT
- SHELL MAIN MENU (default)

If you select RUN INTERACT, the PowerStation loads Interact automatically without interaction from the user. When the user exits Interact, the Shell Main Menu is displayed. This selection is particularly useful if a power cycle should occur because the unit would automatically run Interact when the power is restored.

If you select SHELL MAIN MENU, then the PowerStation loads the Shell and displays the Shell Main Menu.

MOUSE PORT

The MOUSE PORT option automatically detects and displays the port where the mouse is connected if an external mouse is connected to the PowerStation. This port setting is displayed for informational purposes and cannot be changed through the Shell.

TOUCH SCREEN

The TOUCH SCREEN option automatically detects and displays the port where the touch screen is connected if your PowerStation is configured to use a touch screen. This port setting is displayed for informational purposes and cannot be changed through the Shell.

DOWNLOAD ENABLE

Use the DOWNLOAD ENABLE option to select which of the installed serial ports can be used for downloading projects to the PowerStation. When a serial port is enabled for download, the Shell “takes control” of the port to “listen” for the start of a project download; this takeover may interfere with TSRs or network drivers that use that serial port.

To allow other software drivers to use a particular serial port, that port should be set to DISABLED. The Shell automatically disables any serial port enabled for downloading whenever it detects a touch screen or a mouse is connected to it.

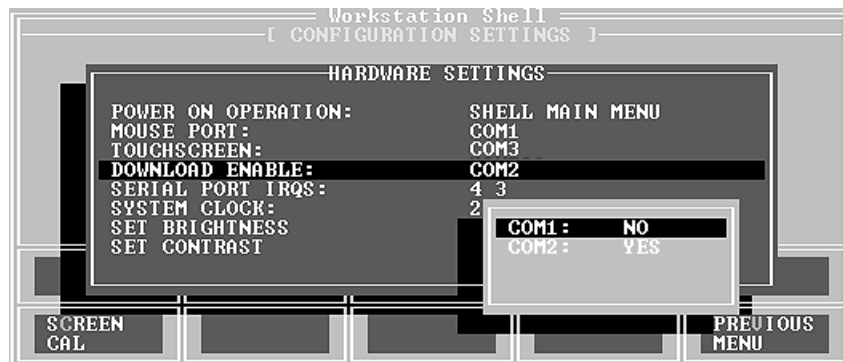

Note It is possible that all the download ports could become disabled by multiple changes to the configuration file. If this occurs, then you will have to manually enable them using the DOWNLOAD ENABLE setting on the SETTINGS menu.

SERIAL PORT IRQS

Use the SERIAL PORT IRQS option to select the communication port IRQ. In order for the Shell to use the installed serial ports for downloading and for touch screen operation, the Shell must have knowledge of the hardware IRQ numbers used by each serial port. These IRQ numbers are typically set by hardware jumpers on the serial boards. The IRQ numbers in the Shell must match the hardware jumper settings for proper operation.

SYSTEM CLOCK

Use the SYSTEM CLOCK option to change the PowerStation's date and time. After you select a parameter, use the numeric keypad to enter the desired value.



The range for each parameter appears below:

DAY	1 - 31	HOUR	0 - 23
MONTH	1 - 12	MINUTE	0 - 59
YEAR	1980 - 2099	SECOND	0 - 59

SET BRIGHTNESS/SET CONTRAST

Use these options to change the brightness and contrast levels of your display. When you select either one of these options, a popup menu will display Increase/Decrease options. Each click on a selection will increase or decrease the brightness or contrast by one level.

Note Not all display types support Brightness and Contrast adjustments. If the installed display does not support Brightness and Contrast adjustments, these menu options will not appear.

Set Path

Select the SET PATH button to enter the path where the Interact application and executable files reside.

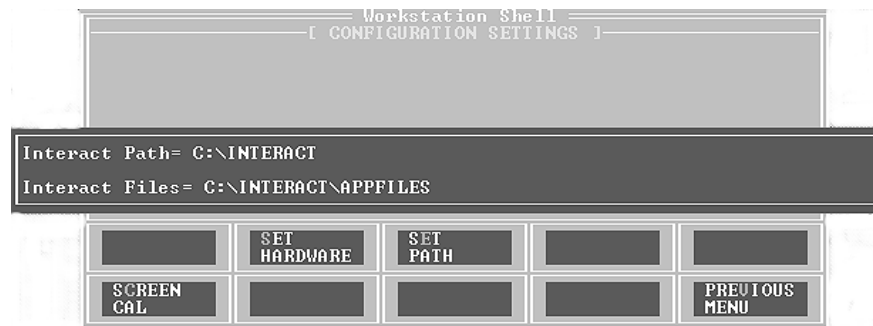

Important Any changes you make to this setting are also made to the “SET INTERACT=” and “SET INTERACT_FILES=” lines in your AUTOEXEC.BAT file. However, these changes will not take effect until you restart the PowerStation or exit the Shell.

Touch Screen Calibration

Select the SCREEN CAL button to launch the touch screen calibration utility. When you select this button, the following message appears:

```
To calibrate the touchscreen:  
- First, select option C to calibrate  
- Then select option V to select video modes  
- Select an appropriate video mode (must do modes 3,  
  12, and 101 - selections 2, 0, and 11 respectively)  
- Select C to calibrate the selected mode  
- Repeat until all needed video modes are calibrated  
Hit any key to begin calibration...
```

Important The touch screen calibration utility requires you to use an external keyboard. See *Keyboard Port* on page 21 for more information about connecting a keyboard to the PowerStation.

See *Recalibrating the Touch Screen* on page 46 for more information about calibrating the touch screen.

System Information

Select the SYS INFO button to provide information on system resources such as the Shell version number, processor type, installed memory, etc. Use this information to assist you during PowerStation configuration. This information will be requested whenever you contact CTC's Product Technical Support department for assistance.



The following items appear on the System Information Menu:

Name	Description
SOFTWARE ID	Identifies the version of the Shell utility.
PROCESSOR	Identifies the type of processor installed in the PowerStation.
INSTALLED MEMORY	Lists the amount of DRAM installed in the PowerStation in Kbytes.
DRIVES	Lists the type and size of the drives installed on the PowerStation along with the amount of free disk space. The flash drive is identified as a "hard disk" in the list.

Port Usage

Select the PORT USAGE button to view the port memory assignments for the PowerStation. An example of this window appears below. Your screen may differ from this one based on your hardware configuration.

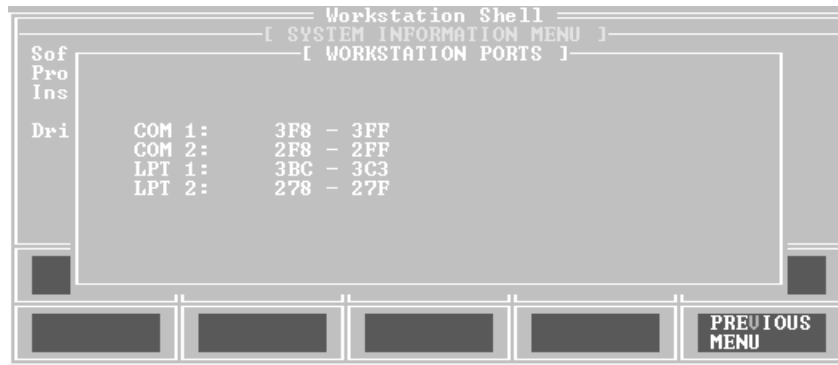

Memory Map

Select the MEMORY MAP button to display the memory map of the PowerStation. Use this menu whenever you install I/O cards that use memory addresses to make sure the card does not conflict with the PowerStation's memory addresses. See *Using a Touch Screen with Interact* on page 27 for more information.

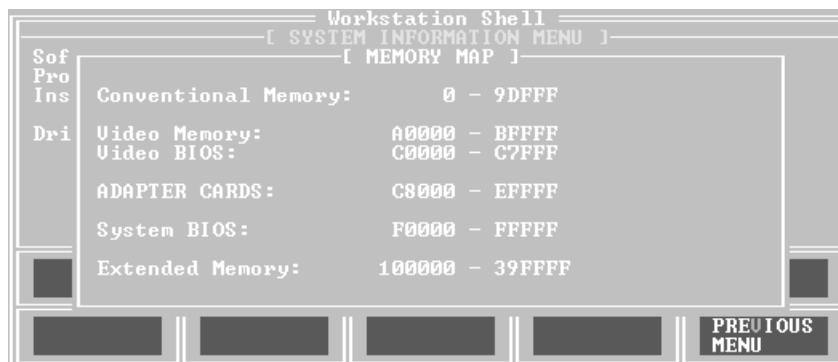

Go To Interact

Select the GO TO INTERACT button to execute Interact from the Shell. Doing so provides the proper environment for Interact to create and use the applications within the currently selected project.

The Interact module displayed is determined by the project's Startup Application configuration setting in the Application Manager. If this setting is None, then the Application Manager Main Menu is displayed. Upon exiting Interact, the Shell Main Menu appears.

Utility Menu

Select the UTILITY MENU button to enter the Shell Utility menu. The Utility menu allows you to do the following:

- Access the Interact security device
- View directory names and file names, including their size and date/time information

Security Key

Use this option to activate the Interact Setup Utility (ISU), which allows you to enable options and transfer enabled options between security keys. Refer to the Interact Getting Started guide for more information about using security keys. To upgrade the key and enable or transfer modules and drivers, follow the basic guidelines listed below:

- To upgrade the PowerStation's internal key, place the upgrade key on the LPT1 (parallel) port and use the Upgrade command in ISU.
- To enable modules and drivers on the PowerStation's internal key, use the Enable Option command in ISU.
- To transfer modules and drivers to the PowerStation's Internal Key, place a key with the enabled module or driver on the LPT1 port of the PowerStation and use the Transfer Option command in ISU.

Note When you choose the Enable Option command, a numeric keypad appears so you can enter enabling codes. This eliminates the need for an external keyboard.

Dir

Use this option to display a list of all files and directories on the PowerStation. Select the desired drive letter and directory to display the files in that directory.

The directory path is listed at the top of the screen. The number of files, the total number of bytes in this directory, and the total number of bytes remaining on this drive are listed at the bottom of the screen. This menu also displays file names with their size and the date and time the file was created.

If the list of files is greater than what can be displayed on screen, then you can scroll and page through the list. Use the arrow keys to scroll through the list or press the Page Up or Page Down keys.

Exit Shell

Select the EXIT SHELL button to exit the Shell program and return to DOS. When you select this button, the Shell reminds you that you must have a keyboard connected to the PowerStation before you can exit the Shell. If you have a keyboard connected to the PowerStation, select YES to exit the Shell. You can restart the Shell at any time by typing PSU and pressing the Enter key on the keyboard.

System Tests

Select the SYSTEM TESTS menu to display a submenu of tests that you can perform on the PowerStation. At this time, you can perform a keyboard test by pressing the KEYBOARD TEST button.

Keyboard Test

Select the KEYBOARD TEST button to begin the keyboard test. When you press a key, the PowerStation will display the text string that matches that key.



Note If your PowerStation has a touch screen, upon pressing the display the text string “SELECT” is displayed. Also, pressing the Shift, Ctrl, and Alt keys does not display a text string.

DOS Shell

Select the DOS SHELL button to enter DOS mode without exiting the Shell. You will need to connect a keyboard to the PowerStation prior to selecting this feature. CTC installs critical DOS utilities on the PowerStation’s flash drive. Refer to your DOS manual for information about using DOS commands. To return to the Shell, type `exit` at the prompt.

Reinstalling the Shell Software

The PowerStation Shell comes pre-installed on the PowerStation's compact flash (CF) card. This section explains the procedure to reinstall the Shell software onto a formatted and bootable CF card. If you need to reformat the CF card, see *Reformatting the Compact Flash* on page 56.

This procedure may be necessary if certain critical files are deleted or corrupted on the card or to prepare a new card for use. This procedure requires the following items:

- PC with a Type II PCMCIA slot and a 3.5" floppy drive running MS-DOS 6.22 or Windows 95
- CF-to-PCMCIA adapter (available from CTC)
- Shell Installation disk (KA-72451-200 or later)

Note This procedure will work correctly under only MS-DOS 6.22, Windows 95, or Windows 98. Do not run this utility under Windows NT.

1. Power down the PowerStation.

Important Always make sure power to the PowerStation is turned OFF when inserting or removing the CF card.

2. Remove the flash card from the PowerStation flash card slot.

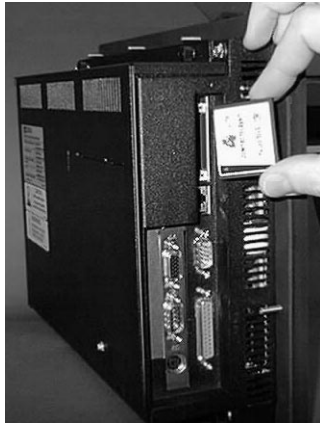

3. Insert the CF card into the PC's PCMCIA slot, using the CF-to-PCMCIA adapter.

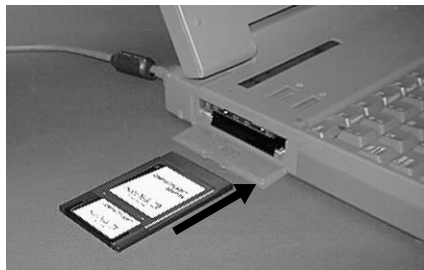

The PCMCIA drivers should recognize and configure the card as an ATA card, assigning an additional drive letter for the card (e.g., D:).

Note In this example, drive D: represents the PCMCIA card; however, your system may assign a different drive letter to the PCMCIA card.

4. Insert the Shell Installation disk into the PC's floppy drive.
5. Enter MS-DOS mode.
6. At the DOS prompt, type the following command sequence:
A: INSTALL A: D:
7. Press Enter to execute this command.

This will install the PowerStation Shell files and necessary drivers onto drive D (or the drive assigned to the CF card in the PCMCIA slot). You will be asked whether you wish to install the standard CTC AUTOEXEC.BAT and CONFIG.SYS files as part of the installation. CTC recommends that you answer "Yes."

If you answer Yes, the existing AUTOEXEC.BAT and CONFIG.SYS files will be renamed to AUTOEXEC.OLD and CONFIG.OLD. If you answer No, the factory-default files will be copied to AUTOEXEC.CTC and CONFIG.CTC in the root directory of drive D, and you will need to manually update your existing AUTOEXEC.BAT and CONFIG.SYS later.

After the AUTOEXEC.BAT and CONFIG.SYS files have been copied on to your system, press any key to continue. You will be asked if you want to calibrate the touch screen; however, you cannot do this until you reinstall the CF card in the PowerStation.

8. Press N when you are asked if you want to recalibrate the touch screen.
The PowerStation Shell installation is complete.
 9. Eject the CF-to-PCMCIA adapter, and remove the CF from the adapter.
The CF card is now ready to use in the PowerStation.
- Important** Always make sure power to the PowerStation is turned OFF when inserting or removing the CF card.
10. Insert the CF into PowerStation's flash card slot.
 11. Power up the PowerStation.
The PowerStation automatically boots into the PowerStation Shell.
 12. Recalibrate the touch screen. See *Recalibrating the Touch Screen* on page 46 for complete instructions.

Recalibrating the Touch Screen

The PowerStation's touch screen is calibrated prior to leaving CTC. However, you may need to recalibrate the touch screen when you begin using the PowerStation for the first time or whenever the cursor location and the location on the screen where the user touches do not match.

The PowerStation Shell comes with a calibration utility that you can use to calibrate the touch screen. The calibration utility requires a keyboard and involves calibrating the touch screen for text and for graphics. Follow these steps to calibrate the touch screen:

1. Select the SCREEN CAL button from the CONFIG SETTINGS menu.
The following screen appears:

```
To calibrate the touchscreen:
- First, select option C to calibrate
- Then select option V to select video modes
- Select an appropriate video mode (must do modes 3,
  12, and 101 - selections 2, 0, and 11 respectively)
- Select C to calibrate the selected mode
- Repeat until all needed video modes are calibrated
Hit any key to begin calibration...
```

2. Press any key when you are ready to begin the calibration program. The following screen appears:

```
Touch Screen Driver Configuration Utility 2.0.1T1 22-Sep-98
Dynapro Technologies Inc (C)

  Calibration
  Display
  Touchsurround
  Buttons
  Interface
  Exit

Enter your selection (C/D/T/E/I/E):
```

3. Press C for Calibration. When the next screen appears, you will be calibrating video mode 80 x 25 Text (2,3).
4. Press C again for Calibrate.
5. Place your finger on the square on the screen and hold until you hear a beep.
6. Follow the instructions on the screen by touching each square as it appears—there will be three all together.
7. Press V to select a new video mode.
8. Enter 0 for 640 x 480 16 color Graphics mode.
9. Press Enter.
10. Press C for Calibrate.
11. Follow the instructions on the screen by touching each square as it appears—there will be three all together.
12. Press V for video mode.
13. Enter 11 for 640 x 480 256 color Graphics mode.
14. Press Enter.
15. Press C for Calibrate.
16. Follow the instructions on the screen by touching each square as it appears—there will be three all together.
17. Press O for OK.

18. Press Esc or X to exit.

Important After calibrating the touch screen, enter Interact in Program Mode. Verify that the cursor appears on the screen where you touch, otherwise recalibrate the screen. The calibration **MUST** be accurate to avoid activating a button unintentionally during Run Mode.

Installing the PowerStation

When you finish configuring the PowerStation, you can begin making preparations to install the unit in a permanent location. This chapter will help you select an appropriate location for the unit, provide instructions for creating a cutout for the unit, and describe how to install the unit.

Chapter Contents

<i>Selecting a Location</i>	50
<i>Creating the Cutout</i>	52
<i>Installing the Unit</i>	53
<i>Powering Up the Unit</i>	54

Selecting a Location

The first step to installing the PowerStation is to select an appropriate location for the unit. This is the most important aspect of the installation because the location you select can affect the PowerStation's performance, ease-of-use, life-expectancy, and more. This section provides some guidelines that you should follow when selecting a location for the PowerStation.

Class I, Division II Guidelines

If you purchased a Class I, Division II compliant PowerStation, you must always follow these guidelines to maintain a safe operating environment:

1. Suitable for use in Class I, Division II, Groups A, B, C, and D hazardous locations only.
2. **Warning: Explosion Hazard**—Do not disconnect equipment, replace, or insert cards unless power has been switched to the off or the area is known to be non-hazardous.
3. **Warning: Explosion Hazard**—Substitution of components may impair suitability for Class I, Division II.
4. Make sure that the PowerStation's power cord is always secured to the unit using the supplied L bracket.
5. When performing field wiring, always use copper wire with 60C or 60/75C insulation and a tightening torque of 7.0 lb/in. (0.79 N-m).

Environmental Guidelines

The environment is the area where the PowerStation will be located. In general, you should limit the unit's exposure to adverse conditions such as dust, oil, moisture, and corrosive vapors.

Faceplate Considerations

The PowerStation's faceplate is designed to the NEMA 4 (IP65 European standard) rating. You should mount the PowerStation in a similar enclosure to provide further protection. The PowerStation's faceplate is resistant to a variety of chemicals. See *Faceplate Chemical Resistance* on page 13 for a complete list of these chemicals.

Electrical Guidelines

To minimize unwanted electrical interference, select a location away from machinery that produce intense electrical noise. If this cannot be avoided, isolate input power to the unit and separate all data communication cables used with the unit from AC power lines.

See *Electrical Specifications* on page 12 for a list of electrical specifications. Make sure that your power source is completely compatible with the PowerStation before starting the unit.

Temperature Guidelines

You can safely operate the PowerStation within the temperature range specified in the *Environmental Specifications* section on page 11. If you are using a protective enclosure, remember that the temperature outside the enclosure is generally lower than the internal temperature. Thus, if the PowerStation is operating inside an enclosure at temperature levels above its rated ambient temperature, it will be necessary to cool the enclosure.

Enclosure Guidelines

Select an enclosure that is large enough to allow free airflow in and around the unit. You should allow a minimum of a 2-inch gap between the enclosure and the top, bottom, and sides of the PowerStation.

Also, make sure that the surface of the enclosure on which the PowerStation is mounted is flat and free of raised or depressed areas.

AC Power Guidelines

If you have purchased the optional AC power supply for the PowerStation, you must select a location that provides protection from dust, oil, moisture, and corrosive vapors. If you have a large enough enclosure, you can mount the power supply either on the back of the PowerStation or elsewhere in the enclosure with the unit.

Note If you decide to mount the power supply in an enclosure, mounting it flat on the bottom of the enclosure or horizontally on the side of the enclosure provides the best convection cooling.

Creating the Cutout

Once you have selected a location, you can begin preparing it to accept the unit. Prior to installing the PowerStation, you will need to create a cutout for the unit and clean the area of any dirt or debris that may come in contact with the unit.

The PowerStation comes with a template that is designed to simplify the task of creating the cutout for the unit. Be sure to follow the drill hole and cutout dimensions precisely so the PowerStation properly seals. Follow these steps to create the cutout:

1. Attach the template securely to the mounting surface.
2. Cut out the shaded area of the template referred to as the 'Panel Cutout Area.' To maintain the flatness of the mounting surface, CTC recommends that you **cut** out the Panel Cutout Area rather than punch it out.
3. Drill the appropriate number of 0.23-inch diameter mounting holes as seen on the template. Once again, you should be careful to protect the flatness of the surface.
4. Debur the cutout area and the drill holes.
5. Ensure that the mounting surface has remained flat and that the panel surface is clean and free of foreign materials.
6. See *P2 PowerStation Dimensional Drawings* on page 85 in Appendix A for the depth and port dimensions of your PowerStation. Use these dimensions to customize the mounting of your unit.

Preparing to Use an AC Power Supply

When you purchase the optional AC power supply and mounting kit for the PowerStation, you can mount the power supply either on the back of the PowerStation or elsewhere in the enclosure with the unit. The mounting kit includes a template that you can use to prepare a location for the power supply. Follow these steps to prepare the power supply mounting surface:

1. Securely attach the template to the mounting surface.
2. Drill and debur four 0.17" (4.3mm) holes.

Installing the Unit

Once you have prepared the mounting location for the PowerStation and the AC power supply (if purchased), you can begin installing the unit.

Mounting the Unit

Once the mounting surface has been prepared, you can install the PowerStation. For your convenience, CTC includes all necessary mounting hardware with the unit. Follow these steps to mount the unit:

1. Gently insert the PowerStation into the cutout.
2. Install a nut on each of the protruding studs on the back of the panel, and tighten each nut to a torque of 17 inch/pounds.

Important The unit must fit flush in the enclosure. Tighten the nuts in a cross-wise sequence to ensure a good seal and prevent damage to the unit.

Mounting the AC Power Supply

The AC power supply is designed to be mounted using two metal brackets. These brackets are secured to the mounting surface using four screws. For your convenience, CTC provides all necessary hardware for mounting the power supply in a special mounting kit. Follow these steps to mount the power supply:

1. Prepare the power source for the unit by sliding the positive and negative wires into the appropriate slots on the power connector.
2. Connect the ground cable from the power connector to an earth ground.
3. Attach the power supply to the mounting surface using the supplied metal brackets.
4. Connect the power cord from the power supply to an AC power source.
5. Secure the power cable to the power supply using the supplied L-shaped metal bracket and nut.
6. Attach the power connector that you prepared in steps 1 and 2 to the back of the PowerStation.

Powering Up the Unit

Once the unit has been mounted, you are ready to power up the unit. This procedure appears below.



Before connecting a power cord to your unit, make sure you have read and understand the following sections of this manual: *Electrical Specifications* on page 12 and *Testing Specifications* on page 13. Also, make sure you follow the guidelines listed below:

- For PERMANENTLY CONNECTED EQUIPMENT, a readily accessible disconnect device shall be incorporated in the fixed wiring.
- For PLUGGABLE EQUIPMENT, the socket-outlet shall be installed near the equipment and shall be easily accessible.

Special note for use in EU member countries

Proper installation of this PowerStation model for use in European Union countries requires the use of a harmonized power cord (the power cord must be identified with the <HAR> symbol). Ensure that this PowerStation is connected to the main supply only with a harmonized power cord.

1. Verify that the power switch is OFF.
2. Connect the power cord to your voltage source. Voltage input to the unit should be within the range specified in the *Electrical Specifications* section on page 12 of this manual.
3. Connect the power cord plug to the PowerStation.
4. Turn the power switch ON.

Note The fan should come on followed immediately by the display.

Now you are now ready to download your project to the PowerStation. Refer to the Interact Project Manager User Guide for more information about downloading projects to the PowerStation.

Maintaining and Troubleshooting the PowerStation

The PowerStation has been designed to provide years of trouble-free operation even in the harshest environments. However, you will occasionally need to perform routine maintenance on some of the PowerStation's components.

This chapter provides troubleshooting advice as well as instructions on reformatting the flash drive, cleaning the touch screen, and recalibrating the touch screen.

Chapter Contents

<i>Reformatting the Compact Flash</i>	56
<i>Modifying the AUTOEXEC.BAT File</i>	59
<i>Configuring the Touch Screen Drivers</i>	60
<i>Configuring the Ethernet Interface</i>	62
<i>Performing Internal Maintenance/Upgrades</i>	63
<i>Cleaning the Touch Screen</i>	72
<i>Resolving Common Problems</i>	72

Reformatting the Compact Flash

This section explains the procedure to create a bootable Compact Flash (CF) card for the PowerStation from a “blank” CF card. This procedure may be necessary if certain critical files are deleted or corrupted on the card or to prepare a new card for use. This procedure requires the following items:

- PC with a Type II PCMCIA slot and a 3.5" floppy drive running MS-DOS 6.22, Windows 95, or Windows 98
- CF-to-PCMCIA adapter
- ROM-DOS 6.22 and Utilities distribution disk (KA-72579-101 or later)
- Shell Installation disk (KA-72451-200 or later)

Note This procedure will only work correctly under MS-DOS 6.22, Windows 95, or Windows 98. Do not run this utility under Windows NT.

1. Power down the PowerStation.

Important Always make sure power to the PowerStation is turned OFF when inserting or removing the CF card.

2. Remove the flash card from the PowerStation flash card slot.



3. Insert the CF card into the PC's PCMCIA slot, using the CF-to-PCMCIA adapter.



The PCMCIA drivers should recognize and configure the card as an ATA card, assigning an additional drive letter for the card (e.g., D:)

Note In this example, drive D: represents the PCMCIA card; however, your system may assign a different drive letter to the PCMCIA card.

4. Enter MS-DOS mode.
5. At the DOS prompt, type the following command sequence:
FORMAT D:
6. Press Enter to execute this command.
7. Insert the ROM-DOS 6.22 and Utilities disk into the PC's floppy drive.

Important If you are performing the install procedure in a DOS window under Windows 95 or Windows 98, you must execute the command `LOCK D:` before entering the `INSTALL` command shown below. After the ROM-DOS installation is complete, execute the `UNLOCK D:` command.

8. At the DOS prompt, type the following command sequence:
A: INSTALL A: D:
9. Press Enter to execute this command.

This will install the ROM-DOS system files onto the CF card to make the card bootable and create a DOS directory containing a few basic ROM-DOS utilities (HIMEM.SYS, EMM386.EXE, etc.).

10. Insert the Shell Installation disk into the PC's floppy drive.

11. At the DOS prompt, type the following command sequence:

```
A:INSTALL A: D:
```

12. Press Enter to execute this command.

This will install the PowerStation Shell files and necessary drivers onto drive D (or the drive assigned to the CF card in the PCMCIA slot). You will be asked whether you wish to install the standard CTC AUTOEXEC.BAT and CONFIG.SYS files as part of the installation. CTC recommends that you answer “Yes.”

If you answer Yes, the existing AUTOEXEC.BAT and CONFIG.SYS files will be renamed to AUTOEXEC.OLD and CONFIG.OLD. If you answer No, the factory-default files will be copied to AUTOEXEC.CTC and CONFIG.CTC in the root directory of drive D, and you will need to manually update your existing AUTOEXEC.BAT and CONFIG.SYS later.

After the AUTOEXEC.BAT and CONFIG.SYS files have been copied on to your system, press any key to continue. You will be asked if you want to calibrate the touch screen; however, you cannot do this until you reinstall the CF card in the PowerStation.

13. Press N when you are asked if you want to recalibrate the touch screen.

The PowerStation Shell installation is complete.

14. Eject the CF-to-PCMCIA adapter and remove the CF from the adapter.

The CF card is now ready to use in the PowerStation.

Important Always make sure power to the PowerStation is turned OFF when inserting or removing the CF card.

15. Insert the CF into PowerStation’s flash card slot.

16. Power up the PowerStation.

The PowerStation automatically boots into the PowerStation Shell.

17. Recalibrate the touch screen. See *Recalibrating the Touch Screen* on page 46 for complete instructions.

Modifying the AUTOEXEC.BAT File

The following lines must appear in the AUTOEXEC.BAT file for proper operation of the PowerStation. The AUTOEXEC.BAT file that CTC supplies includes these lines and is located in the \CTC directory of the PowerStation in a file called AUTOEXEC.CTC.

Command line parameter	Description
PATH C:\; C:\DOS; C:\CTC	Sets up default DOS path.
LH C:\CTC\BIOSTSR	Loads special functions.
C:\CTC\ISVESA IF ERRORLEVEL 1 GOTO NOVESA GOTO YESVESA :NOVESA LH C:\CTC\VESA :YESVESA	Loads VESA video support TSR, if necessary.
IF EXIST C:\CTC\MOUSE.INI DEL C:\MOUSE.INI	Required for shell to detect mouse in some situations.
C:\CTC\MOUSE	Loads MOUSE.COM if a mouse is connected.
LH C:\TOUCH\DOX\SC3DOX.EXE /NOBOUNDS	Initializes mouse emulation for touch screen (DOS).
SET INTERACT=C:\INTERACT	Sets the Interact path.
SET INTERACT_FILES=C:\INTERACT\APPFILES	Sets application path for Interact.
SET INTERACT_STARTUP=C:\STARTUP	Sets up Interact startup variables.
IF EXIST C:\STARTUP\AUTOEXEC.BAT CALL C:\STARTUP\AUTOEXEC.BAT	Calls second AUTOEXEC.BAT file if contained within a Project.
CD\NET CALL C:\NET\NET.BAT	Loads network batch file if unit is connected to a LAN. Remove "REM" to activate.
CD\CTC PSU	Starts the PowerStation Shell.

Configuring the Touch Screen Drivers

The C:\TOUCH\DOX\SC3DOX.EXE file is needed to configure the touch screen in MS-DOS. This file initialized the touch screen driver.

Important If you purchased a PowerStation with the touch screen disabled and you want to enable it, remove the REM statement that appears at the beginning of the above line.

Likewise, if you purchase a PowerStation with the touch screen enabled and you want to disable it, add the word REM to the beginning of this line. If you need to permanently disable the touch screen, remove the file SC3DOX.EXE from your system.

The SC3DOX accepts the following command line parameter NOBOUNDS—this specifies the touch screen boundaries in Interact.

Important DO NOT change this parameter.

Follow the directions below to configure the touch screen drivers:

1. Enter MS-DOS mode and change to the C:\TOUCH\DOX directory.
2. Start the touch screen calibration program by typing touchcfg. The following touch screen driver configuration screen will appear.

```
Touch Screen Driver Configuration Utility 2.0.1T1 22-Sep-98
Dynapro Technologies Inc (C)

  Calibration
  Display
  Touchsurround
  Buttons
  Interface
  Exit

Enter your selection (C/D/T/B/I/E):
```

3. Press **I** for Interface. The following Interface Configuration Options screen will appear.

```
Interface Configuration Options
Interrupt:      IRQ11
Address:       3E8h
Connection:    UART
calibratiON data: Controller
Set COM1:
Set COM2:
Set COM3:
Set COM4:
Reset:
aDvanced:
Ok:

Enter your selection (I,A,C,N,1,2,3,4,R,D,O):
```

4. Press **I** to change the Interrupt or press 1, 2, 3 or 4 to change the COM port.

Note If you use Set COM3 or COM4, they will default to COM1 and COM2 IRQs. You will need to reset them.

5. Press **A** to change the Address.
6. Press **C** to change the Connection.
7. Press **O** to set your touch screen driver.
8. Press **Esc** or **X** to exit.

Important You must reboot your system for the changes to take effect.

Configuring the Ethernet Interface

The \NET directory of the PowerStation's flash drive contains a configuration utility and all drivers necessary to configure the Ethernet interface. CTC also includes backup copies of these files on the PowerStation Shell Installation Disk. These files are described below:

File Name	Description
AT5CFG.EXE	A configuration utility you can use to change the interrupt and address of the Ethernet interface.
NET.BAT	A sample batch file you can use to run NetBIOS.
NET.CFG	Stores the interrupts and memory for the network drivers. The default PowerStation configuration reserves the following interrupts and I/O addresses. You cannot use these for the Ethernet interface. <ul style="list-style-type: none"> • COM1: Int 4, I/O 3F8 • COM2: Int 3, I/O 2F8 • Touch Screen: Int 15, I/O 310 CTC recommends that you use the following interrupt and I/O address setting for the Ethernet interface: Int 10, I/O 280H
NETX.EXE	The Novell Netware shell program that makes the final connection with the server.
*LSL.COM	A Novell driver that enables the workstation to communicate with different protocols.
*IPXODI.COM	A Novell driver that supports the IPX protocol and other protocols over the same network.
*NE2000.COM	A Novell driver that supports the NE2000 protocol. It allows the PowerStation to communicate over a local area network.
*NETBIOS.EXE	Used by Interact to communicate over a network.

* Denotes files that can be downloaded from Novell's FTP site: <ftp://137.65.3.15/pub/updates/dsktop/nw111/111d03.exe>

Interact will also communicate over any network or operating system that supports NetBIOS protocols. Examples include Lantastic, Microsoft, and IBM. If you need assistance with NetBIOS and networking, consult your network administrator or a certified network technician.

Performing Internal Maintenance/Upgrades

This section includes helpful information for performing internal maintenance on the PowerStation. To prevent injury to yourself and/or damage to the PowerStation, be sure to read and understand the procedures found in this section before performing the procedures. This section will show you how to perform the following operations:

- Remove and replace DRAM
- Add PC/104 modules
- Change jumper settings

Electrostatic Discharge Precautions

Modern integrated electronic devices, especially CPUs and memory chips, are extremely sensitive to electrostatic discharges (ESD) and fields. Before you disassemble the PowerStation, be sure to follow these simple precautions to protect you and the PowerStation from harm resulting from ESD.

1. To avoid electric shock, always disconnect the power from the PowerStation before you remove the backshell cover or separate the backshell from the front panel. Do not touch any components of the CPU card or other cards while the PowerStation is on.
2. Disconnect power before making any hardware configuration changes. The sudden rush of power as you connect a jumper or install a card may damage sensitive electronic components.
3. Only handle internal components in an ESD-safe location using appropriate grounding methods.
 - Always ground yourself to remove any static charge before you touch the CPU card.
 - Be particularly careful not to touch the chip connectors.
 - Keep any card in its anti-static packaging when it is not installed in the PowerStation and place it on a static dissipative mat when you are working on it.
 - Wear a grounding wrist strap for continuous protection.

Disassembling the PowerStation

If you have read and understand the ESD safety precautions, you are ready to disassemble the PowerStation. Follow these steps to disassemble the unit:

Important As you begin to disassemble the unit, you will encounter several different screw sizes. When you reassemble the PowerStation, be sure to replace the same size screw in the same location as the one that was removed. Failure to do so could result in damage to the unit.

1. Turn off power to the unit.
2. Disconnect the unit from the power source.
3. Remove the unit from its enclosure, if installed.
4. Place the unit on a static-dissipative mat in a location free from dirt and moisture and protected against static discharge. You must also wear an ESD wrist strap connected to a good known earth ground.
5. Place the unit face down and remove the screws securing the back cover.
6. Remove the back cover from the unit.
7. Proceed to the specific configuration or replacement procedures you need to perform.
 - See *Adding and Replacing DRAM* on page 65
 - See *Adding PC/104 Modules* on page 66
 - See *Changing the Jumper Settings* on page 68

Adding and Replacing DRAM

All PowerStations use DRAM that is comparable to what is found in most PC's. The size and quantity of DRAM varies depending on the PowerStation model and the CPU card. However, the same procedure applies to add and replace DRAM on all models. Refer to the CPU manual for more information about the size and quantity of DRAM your unit can support.

Removing a DRAM module

If you are upgrading your PowerStation's DRAM, you may need to remove the existing DRAM module from the CPU card. Follow these steps to remove a DRAM module.

1. Locate the DRAM SIMM sockets located on the left side of the CPU card. The number of SIMM sockets varies depending on the PowerStation model and the manufacturer of the CPU card.

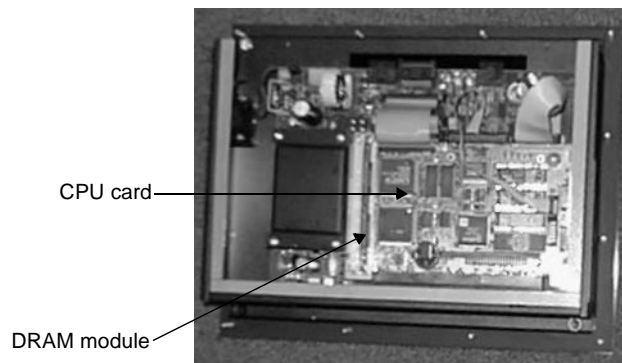

2. Push outward on the socket ejectors. It might be necessary to use a small screwdriver or the tip of a pen to push on the ejectors.
3. Tilt the DRAM module slightly to the left, and lift the module out of its socket at an angle.
4. Place the DRAM module in an anti-static bag for storage if you do not plan to reinstall the DRAM module at this time.

Installing a DRAM module

Follow these steps to install a DRAM module.

1. Carefully insert the DRAM module into its socket at a 45-degree angle. The notch on the bottom of the DRAM module should align with the ridge on the socket.

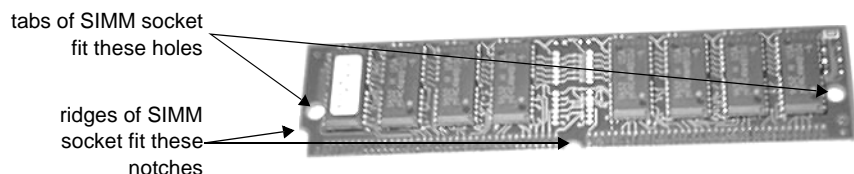

2. Gently but firmly push the module upright into the socket until the metal clips snap into place, securing the module.

Adding PC/104 Modules

The PowerStation supports PC/104 expansion modules. These modules perform a variety of functions that are typically done by traditional plug-in expansion cards. However, the advantage of using PC/104 modules is that you can stack several modules together, saving valuable space. When adding modules to the PowerStation, keep the following information in mind:

- The total combination of modules may not exceed the current limits specified for PC/104 modules in the PowerStation. See *Electrical Specifications* on page 12 for more information about the voltage and current available for expansion cards.
- The PowerStation does not support Plug-n-Play features. When selecting PC/104 modules you must either select those with Plug-n-Play features that can be disabled or those without Plug-n-Play features. PC/104 modules with Plug-n-Play enabled may not perform correctly and may adversely affect PowerStation operation.

Safety Precautions

Observe normal precautions against electrostatic discharge (ESD) to prevent damage to your PowerStation or to your adapter boards. Anyone handling internal components should do so only in an ESD-safe location and should use appropriate grounding methods.

To avoid electric shock, always disconnect power from the unit before you remove the backshell cover or separate the backshell from the front panel.

Address Considerations

As in most ISA-bus computers, port addresses 300 through 31F are available for adapter functions. Addresses 310 through 317 are reserved for use by the PowerStation. Make sure that any adapter cards you install do not conflict with these addresses.

IRQ Considerations

IRQs 3, 4, 5, 7, 9, 10, 11, and 15 are available to adapter devices connected to the ISA-bus. The PowerStation configures these as shown below.

IRQ	Usage	Jumper Location
3	COM2*	CPU card
4	COM1	CPU card
5		
7		
9		
10	Ethernet*	Power Supply board
11	Touch Screen*	Power Supply board
15		

The IRQs in this table that are blank are available for use by any adapter card. Those marked with an asterisk (*) may be reconfigured by changing the jumper settings on the PowerStation's Ethernet/Power Supply board or the CPU card. Changing jumpers requires you to also change the operating software. You should only make these changes after consulting the CTC Product Technical Support department.

Changing the Jumper Settings

The PowerStation has three sets of jumpers located on the Ethernet/Power Supply board that you can change, if necessary. The first set of jumpers (JP1) allows you to restore the Ethernet port to a known configuration of IRQ 10 and I/O address 240H. The second set of jumpers (JP6) allows you to change the IRQ used by the touch screen. The third set of jumpers (JP7) allows you to change the I/O address used by the touch screen.



Note The above illustration shows the Ethernet/Power Supply board with the CPU card removed. See the next page for instructions on how to remove the CPU card.

The PowerStation's CPU card also has several sets of jumpers that may also be changed. Refer to the CPU manual that came with your PowerStation for more information about changing these jumpers.

JP1 Ethernet default jumper

This jumper is used to restore the Ethernet configuration to IRQ 10 and I/O 240H. This jumper is located near the IDE hard drive connector on the Ethernet/Power Supply board. To restore the Ethernet configuration to IRQ 10 and I/O 240H, install a clip on this jumper.

JP6 Touch screen IRQ jumpers

This set of jumpers is used to configure the hardware IRQs for the touch screen. The touch screen IRQ jumpers are located at the lower left corner of the Ethernet/Power Supply board, just beneath the CPU card. To change

these jumpers, you may need to remove the CPU card. This procedure is described below.

Removing the CPU card

CTC does not recommend removing the CPU card; however, you may need to do so to change the jumper settings for the touch screen IRQ. The following procedure describes how to remove the CPU card:

1. Disassemble the PowerStation following the procedure described on page 64.

Refer to the graphic below for remainder of this procedure.

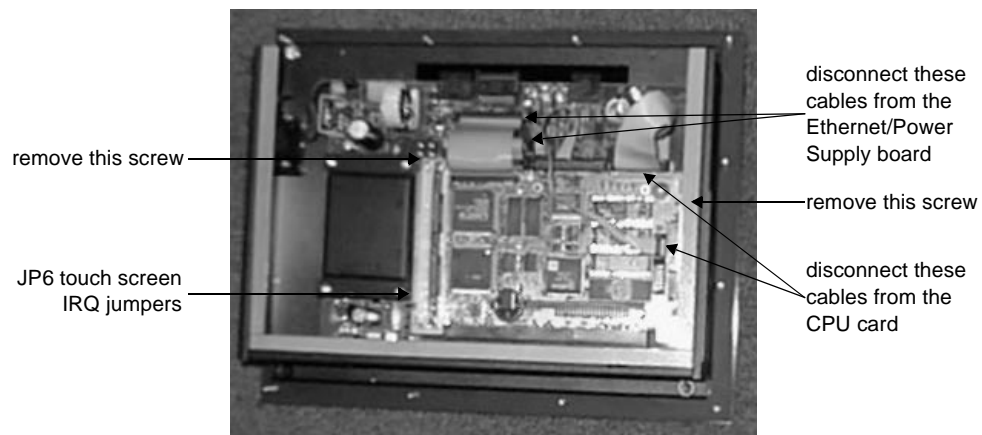

2. Remove the screw that secures CPU card support bracket. This screw is located inside the unit just above the VGA port.
3. Remove the screw that secures the CPU card to the back shell.
4. Disconnect the four cables shown above. Pay attention to which socket you remove each cable from, so you can properly reassemble the unit.
5. Gently push the CPU card out of its socket.
6. Change the touch screen IRQ by moving the clip to the desired jumper. CTC sets the touch screen IRQ to 11.

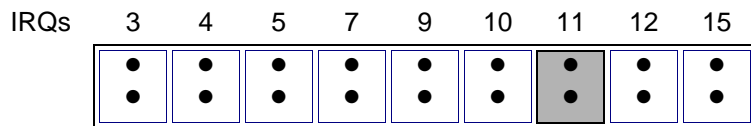

7. Re-install the CPU card by performing steps 1–5 in reverse order.

JP7 Touch screen address

These sets of jumpers configure the address for the touch screen. It is configured by turning “on” or “off” the ports A and B. Use the following chart to determine the on/off combination for the port to which you would like to configure: COM1, COM2, COM3, or COM4.

I/O Address	A	B
COM1 (3F8h)	off	off
COM2 (2F8h)	off	on
COM3 (3E8h)	on	off
COM4 (2E8h)	on	on

To set the touch screen jumpers to the default I/O address COM3 (3E8h), place the clips as seen below with the A port “on” and the B port “off.” Set both jumpers to “on” to map the touch screen to the COM4 port, also shown below.

Important After changing the jumper settings for the touch screen I/O address, you must change the touch screen configuration drivers for the changes to be implemented. See *Configuring the Touch Screen Drivers* on page 60 for more information.

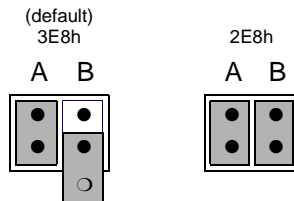

Note The clip for the “off” jumper can be completely removed or placed as in the figure above.

COM2 jumpers

CTC configures the COM2 serial port for RS-485 communications; however, you can configure this port to communicate using RS-232 or RS-422 by changing the jumper settings on the CPU card. To configure COM2 to use RS-232, move the clip to the RS-232 position and move the COM2 cable from RS-422/485 connector to the RS-232 connector.

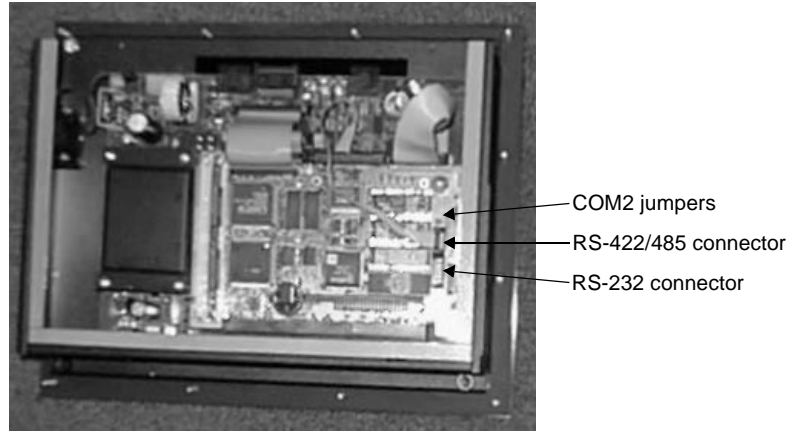

For more information about the COM2 jumpers, refer to the CPU manual that came with your unit.

Reassembling the PowerStation

When you are finished performing internal maintenance on the PowerStation, follow these steps to reassemble the unit.

Important When you reassemble the PowerStation, be sure to replace the same size screw in the same location as the one that was removed. Failure to do so could result in damage to the unit.

1. Replace the back cover and reinstall the screws that secure the back cover.
2. Reinstall the unit in its enclosure, if previously installed.
3. Restore power to the unit by plugging the power cord into the back of the unit.
4. Power up the unit.

Cleaning the Touch Screen

Occasionally, you might find it necessary to clean the touch screen of the PowerStation. Clean the touch screen using warm soapy water and a cloth. You may also use any non-abrasive cleaner. See *Faceplate Chemical Resistance* on page 13.

Do not use any harsh material or powder, such as steel wool or abrasive cleansers, to clean the polyester surface. The surface is sensitive to scraping, sharp blows, or punctures. Thus, keep screwdrivers or other sharp objects away from the surface of the touch screen.

Warning Do NOT clean the unit while Interact is in Run mode. Clean the unit while power is removed to keep from inadvertently activating an Interact device (button, slide, etc.).

Resolving Common Problems

This section provides some basic troubleshooting steps to help you identify and correct problems you may encounter with the PowerStation. If you encounter a problem, please consult this section to see if you can correct the problem yourself. If you encounter a problem that is not documented in this section, contact your CTC equipment supplier or the CTC Product Technical Support department at (513) 248-1714.

Refer to the lists below for the possible troubleshooting topics, how they are organized, and where they are located in this section.

Resolving AUTOEXEC.BAT and CONFIG.SYS problems

Resolving other problems during power up

- During power up, the fan does not come on, and the display is blank (page 75)
- During power up, the fan starts, but the display does not (page 76)
- During power up, the RAM test fails, or the total memory installed does not match the total contiguous RAM listed on the display following the RAM test (page 77)

Resolving problems with the touch screen

- After power up, the touch screen does not work properly, or the touch screen calibration appears to be incorrect (page 78)
- After calibrating the touch screen, it either does not work or follow your finger (page 79)

Resolving other problems after power up

- The PowerStation locks up while booting and will not reboot (page 79)
- A serial mouse does not work (page 80)
- A keyboard does not work (page 80)
- The Ethernet port does not work (page 80)

Resolving problems with Interact

- After power up, the DOS prompt is displayed instead of the PowerStation Shell Main Menu (page 81)
- After selecting the Go To Interact button from the Shell Main Menu, Interact does not run (page 81)
- After selecting the Go To Interact button from the Shell Main Menu, Interact loads, but the screen is blank (page 81)
- You are unable to communicate with the PowerStation's COM ports (page 82)
- You are unable to transfer a project to the PowerStation (page 82)
- Sending a project results in a message on the display indicating the ????.FIL could not be found (page 83)
- A message appears on the PowerStation stating that the disk is full (page 83)
- When you try to run Interact, a message appears on the PowerStation stating that the Interact Security Device is missing or invalid (page 83)
- The PowerStation has corrupted application files, a panel will not load, or modules/drivers will not load (page 83)
- An Interact module (i.e., HTM) does not start up (page 83)
- The code <00> appears on the display during Super User mode (page 84)

Resolving Problems When Powering the Unit

One of the most common problems that users encounter with PCs occurs while booting up their system. This section describes some possible problems and solutions for booting up the PowerStation.

Resolving AUTOEXEC.BAT and CONFIG.SYS problems

Some bootup problems are caused by a corrupted or modified AUTOEXEC.BAT or CONFIG.SYS file. CTC includes backup copies of these files (AUTOEXEC.CTC and CONFIG.CTC) on the PowerStation Utilities Disk. The text for AUTOEXEC.CTC appears below:

```
@ECHO OFF
PROMPT $p$g
SET TEMP=C:\DOS
PATH C:\;C:\DOS;C:\CTC
REM *****
REM Install Powerstation Special Functions
REM *****
LH C:\CTC\BIOSTSR
REM *****
REM Load VESA video support TSR if necessary
REM *****
C:\CTC\ISVESA
IF ERRORLEVEL 1 GOTO NOVESA
GOTO YESVESA
:NOVESA
LH C:\CTC\VESA
:YESVESA
REM *****
REM If an external mouse is connected, MOUSE will install success
REM -fully, and create a new MOUSE.INI file.
REM *****
IF EXIST C:\CTC\MOUSE.INI DEL C:\CTC\MOUSE.INI
LH C:\CTC\MOUSE
REM *****
REM Install Dyanpro SC3 touchscreen drivers
REM *****
LH C:\TOUCH\DOX\SC3DOX.EXE /NOBOUNDS
REM *****
REM Set up Interact environment variables for CTC Shell
REM *****
SET INTERACT=C:\INTERACT
SET INTERACT_FILES=C:\INTERACT\APPFILES
SET INTERACT_STARTUP=C:\STARTUP
REM *****
REM Call AUTOEXEC.BAT file contained in project, if it exists
```

```

REM *****
IF EXIST C:\STARTUP\AUTOEXEC.BAT CALL C:\STARTUP\AUTOEXEC.BAT
REM *****
REM Uncomment next statements to load NOVELL network batch file
REM *****
REM CD \NET
REM CALL C:\NET\NET.BAT
REM *****
REM Start the CTC Shell
REM *****
CD \CTC
PSU

```

The text for CONFIG.CTC appears below:

```

;MS-DOS V6.22, ROM-DOS 6.22 Rev 2.60
FILES=30
DOS=HIGH,UMB
DEVICE=C:\DOS\HIMEM.SYS
DEVICE=C:\DOS\EMM386.EXE NOEMS

```

If at any time you suspect a problem with either the AUTOEXEC.BAT or the CONFIG.SYS file of the PowerStation, use the DOS **copy** command to create a backup copy of your current file and overwrite the suspect file with the appropriate backup file. For example, if the AUTOEXEC.BAT file becomes suspect, type the following commands at the DOS prompt:

```

copy autoexec.bat autoexec.old
copy \ctc\autoexec.ctc autoexec.bat

```

Resolving other problems during power up

This section lists some additional problems and solutions for booting up the PowerStation. The problem is listed first followed by a list of possible solutions. Begin with the first one and continue through the list until you have solved the problem or reached the end of the list.

If the problem persists, look through the other problems listed in this section to determine if additional symptoms exist that require further action. Otherwise, contact your CTC equipment supplier or the CTC Product Technical Support department.

During power up, the fan does not come on, and the display is blank

1. Turn off the PowerStation.
2. Make sure that the power cord is properly plugged in. If it is not, make sure that the plug is firmly attached to the unit and the power source.

Resolving Common Problems

3. Turn on the PowerStation. If the fan does not come on, continue with step 4.
4. Disconnect the PowerStation from its power source.
5. Remove the PowerStation's back cover.
6. Check the fuse located on the internal power supply. If the fuse is blown, replace it. Use a 3.15A, 250 VAC Littelfuse 216.315 or equal.
7. Turn on the PowerStation. If the fan does not come on, continue with step 8.
8. Check connector J2 (fan connection) on the CTC Ethernet/Power Supply board to see if the fan is plugged in.
9. Secure the PowerStation's back cover.
10. Connect the PowerStation to its power source.
11. Turn on the PowerStation.

During power up, the fan starts, but the display does not

1. Turn off the PowerStation.
2. Disconnect the PowerStation from its power source.
3. Remove the PowerStation's back cover.
4. Make sure that the cables that connect to the display are properly connected. If they are not, make sure that each connector is firmly seated in the corresponding plug. Refer to the image below for these cables.

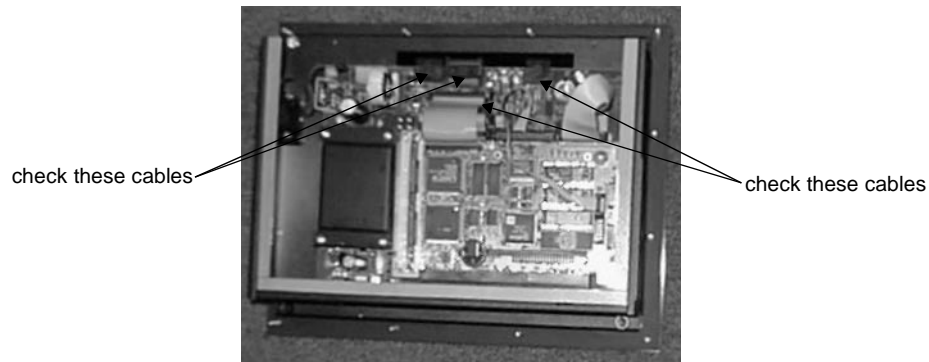

5. Check the installation of the DRAM SIMMs on the CPU board. Make sure that the SIMMs are firmly seated in their sockets and the socket latches are fully engaged.

6. Make sure that all boards are firmly seated.
7. Secure the PowerStation's back cover.
8. Connect the PowerStation to its power source.
9. Turn on the PowerStation.

During power up, the RAM test fails, or the total memory installed does not match the total contiguous RAM listed on the display following the RAM test

1. Turn off the PowerStation.
2. Disconnect the PowerStation from its power source.
3. Remove the PowerStation's back cover.
4. Re-seat the DRAM SIMMs on the CPU board. Make sure that the SIMMs are firmly seated in their sockets, and the socket latches are fully engaged.
5. Secure the PowerStation's back cover.
6. Connect the PowerStation to its power source.
7. Turn on the PowerStation.

Resolving Problems After Powering the Unit

This section lists some possible problems and solutions that may occur after you power up the PowerStation. This section is divided into three sub-sections, one for touch screen problems, one for Interact problems, and one for other problems.

Each section lists some possible problems and solutions that may occur. The problem is listed first followed by a list of possible solutions. Begin with the first one and continue through the list until you have solved the problem or reached the end of the list.

If the problem persists, look through the other problems listed in this section to determine if additional symptoms exist that require further action. Otherwise, contact your CTC equipment supplier or the CTC Product Technical Support department.

Resolving problems with the touch screen

This section lists some possible problems and solutions that may occur with the touch screen.

After power up, the touch screen does not work properly, or the touch screen calibration appears to be incorrect

1. If the PowerStation appears to be operating correctly otherwise, reboot the unit.
2. The touch screen calibration might be in error. See *Performing Internal Maintenance/Upgrades* on page 63 to recalibrate the touch screen.
3. Check the AUTOEXEC.BAT file. See *Resolving AUTOEXEC.BAT and CONFIG.SYS problems* on page 74 for more information.

- a. Verify that the following lines appear before the lines that load touch screen driver:

```
IF EXIST C:\CTC\MOUSE.INI DEL C:\CTC\MOUSE.INI
LH C:\CTC\MOUSE
```

After calibrating the touch screen, it either does not work or follow your finger

1. Make sure the touch screen cable has been properly connected. If the touch screen cable is damaged, replace the touch screen. Contact CTC for information about purchasing a replacement.
2. Inspect the touch screen for broken, loose, or frayed wiring. If you encounter wiring problems, replace the damaged wiring.

Resolving other problems after power up

This section lists other possible problems and solutions that may occur after power up.

The PowerStation locks up while booting and will not reboot

1. Turn off the PowerStation.
2. Connect a keyboard.
3. Turn on the PowerStation. When the message “Starting ROM-DOS” appears, press the F8 key. This will cause the system to step through the CONFIG.SYS or AUTOEXEC.BAT files line-by-line. If the “Starting ROM-DOS” message does not appear, go to step 6.
4. Step through the CONFIG.SYS and AUTOEXEC.BAT files line-by-line until the lockup is found. Remove or correct the offending line in the CONFIG.SYS or AUTOEXEC.BAT.
5. Restart the PowerStation to see if the problem has been solved.
6. If the system locks up before the “Starting ROM-DOS” message appears, reboot the unit and press the Delete key to enter the BIOS setup program.
7. Select the Standard CMOS Setup option or its equivalent and restore the system defaults. This will restore CMOS settings to their factory default configuration. Save these settings and exit the setup program.

Refer to the CPU manual that came with the PowerStation for more information about using the BIOS setup program.

A serial mouse does not work

1. Make sure that the mouse is properly connected to the serial port.
2. If you have connected the mouse to COM2, verify that it is configured for RS-232 communications. See *COM2 jumpers* on page 71 to change the communications protocol for this port.
3. Connect the serial mouse to the port you configured and reboot the PowerStation.

See *Connecting a serial mouse* on page 18 for more information on how to configure the PowerStation to accept a serial mouse.

A keyboard does not work

1. If you are using a keyboard with a PS/2-style connector, make sure that the keyboard is properly connected to the keyboard port.
2. If you are using an AT-style keyboard, complete the following steps:
 - a. Make sure that you have properly connected the keyboard to the supplied PS/2 adapter cable. Make sure that the adapter cable is properly connected to the keyboard port.
 - b. Make sure the keyboard is an AT keyboard NOT an XT keyboard.
 - c. Try a new adapter cable.
3. Try using a new keyboard.

The Ethernet port does not work

1. Make sure the Ethernet cable is plugged in.
2. Make sure the networking software is being loaded. Check the AUTOEXEC.BAT file. See *Resolving AUTOEXEC.BAT and CONFIG.SYS problems* on page 74 for more information. Verify that the following lines do NOT have the word "REM" in front of them:

```
CD \NET  
CALL C:\NET\NET.BAT
```

3. Make sure that you have properly configured the networking software. See *Configuring the Ethernet Interface* on page 62 for more information.

Resolving problems with Interact

This section lists some possible problems and solutions that may occur on a PowerStation that is running Interact.

After power up, the DOS prompt is displayed instead of the PowerStation Shell Main Menu

1. If the PowerStation appears to be operating correctly otherwise, reboot the unit.
2. Make sure the Shell software is being loaded by checking the AUTOEXEC.BAT file. Verify that the following lines do NOT have the word “REM” in front of them:

```
CD \CTC  
PSU
```

3. The AUTOEXEC.BAT file may be corrupted or has been modified. See *Resolving AUTOEXEC.BAT and CONFIG.SYS problems* on page 74 for information about correcting this problem.

After selecting the Go To Interact button from the Shell Main Menu, Interact does not run

1. Verify that the PowerStation’s internal security key is properly configured.
2. Verify that Interact is loaded for this project. Go to the Shell Main Menu, and observe the selection for INTERACT TYPE. If the word UNKNOWN is displayed, return to your development system and download a project that has Interact included. Refer to the Interact Project Manager User Guide for information on downloading projects.

After selecting the Go To Interact button from the Shell Main Menu, Interact loads, but the screen is blank

Interact device driver communications have stopped. Check the following:

- a. Go to the Shell Settings menu and ensure the COM port that the driver is using is selected.
- b. Make sure the COM2 hardware jumpers are selected for the particular protocol used with the driver.

You are unable to communicate with the PowerStation's COM ports

1. Refer to the Interact device driver Program Mode screen of the driver being used to determine if the driver is correctly setup.
2. Verify that the communication cable is wired properly.
3. Make sure the jumpers are set correctly for address and IRQ, without conflicts.
4. Make sure the proper interrupts have been selected in Application Manager.
5. Refer to the programmable controller documentation for proper cable connection instructions.
6. Use a serial port communication test device to check communications between the PowerStation and your controller. These devices can be purchased at local electronics stores.

You are unable to transfer a project to the PowerStation

1. Make sure the PowerStation Shell program is running.
2. Verify the COM port you are using is enabled for download. This parameter is located on the Config Settings/Set Hardware menu of the Shell.
3. Verify that the IRQ settings in the PowerStation Shell match the following settings: COM1=4 and COM2=3.
4. Disconnect any communication cables connected to PowerStation communication cards.
5. Make sure you are not logged onto a network and a print spooler is not connected to your system.
6. Make sure a defective or incompatible mouse or keyboard is NOT connected to the PowerStation.
7. On your computer, do not load a disk cache such as "Smartdrive." This will interfere with your project transfer. Smartdrive could exist either in your computer's CONFIG.SYS or AUTOEXEC.BAT files.
8. Verify that the IPM baud rate located on the Transfer Settings menu is compatible with your PC's COM port.
9. Cycle power to the unit to see if the problem clears.

Sending a project results in a message on the display indicating the ????.FIL could not be found

You must use a Project developed using Interact version 2.1 or higher on a PowerStation. Previous versions of Interact do not have the .FIL file.

A message appears on the PowerStation stating that the disk is full

Verify that Interact Project Manager is set to download to a Runtime Only system. If not, select Runtime Only from the Settings menu of Interact Project Manager, and re-send the project.

If it is already set to Runtime Only, you must make more flash drive space available or reduce the size of the application.

When you try to run Interact, a message appears on the PowerStation stating that the Interact Security Device is missing or invalid

1. Make sure the version of Interact sent to the PowerStation is 4.x or higher.
2. If the error occurred after sending an old PSU Backup to the PowerStation, then the version of Interact is wrong. Restore the old backup to the PC using Interact Project Manager and send the project to the PowerStation. Refer to the Interact Project Manager User Guide for more information about converting PSU backups.
3. If the security key is still not recognized, use the Interact Setup Utility to verify if the key is recognized.

The PowerStation has corrupted application files, a panel will not load, or modules/drivers will not load

1. Attempt to restore a previous backup of your system. If this is not successful go to step 2.
2. Verify that the PowerStation has enough memory available by using the Interact Memory Available button. Your system may need more extended memory.
3. Run CHKDSK.COM on the compact flash drive.
4. Re-download the Interact Project.

An Interact module (i.e., HTM) does not start up

Verify that the security key is programmed with the correct module using the Security Key selection under the Utility Menu of the Shell. See *Security Key* on page 41 for more information about Interact Security Keys.

The code <00> appears on the display during Super User mode

Reboot the PowerStation and return to the Shell or type `exit` to return to the Main Menu. This indicates that a communication problem on the computer occurred. Verify that Interact Project Manager was only executed once.

P2 PowerStation Dimensional Drawings

Side View

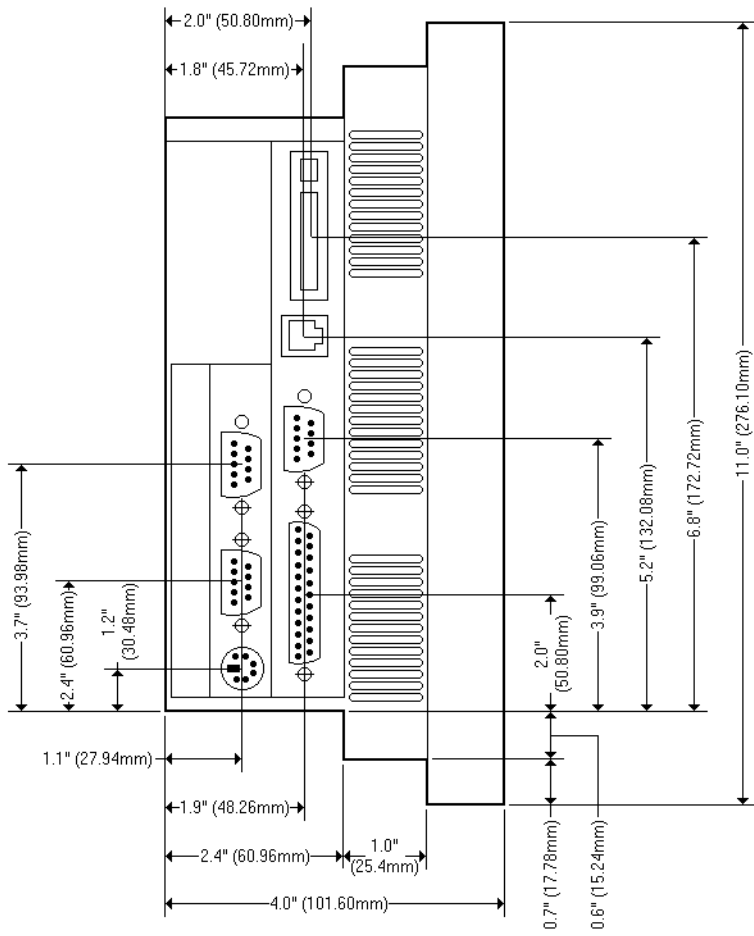

Appendix A

Bottom View

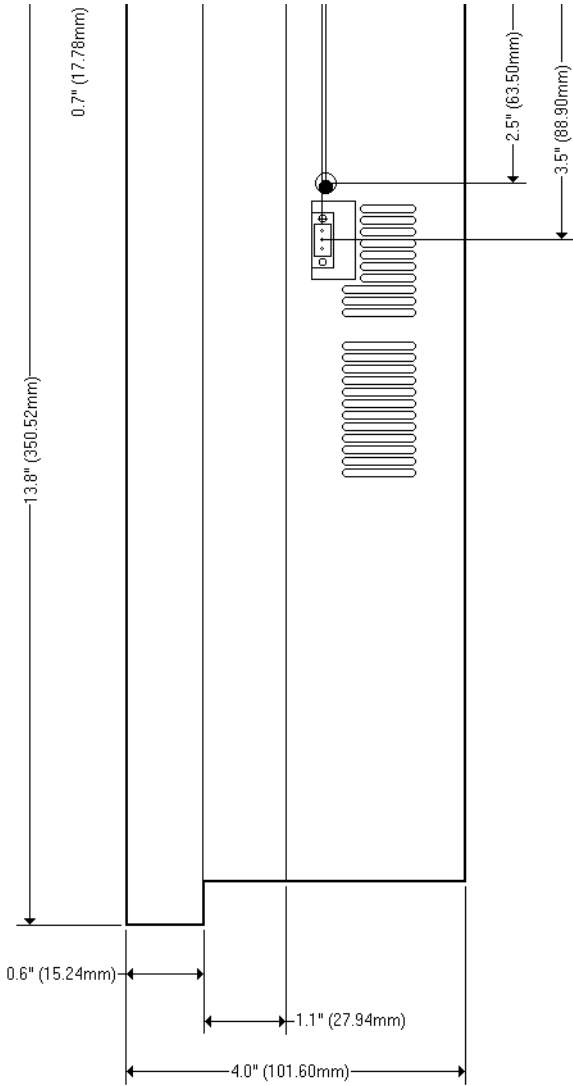

A

- AC power supply 52–53
- address/IRQ considerations 67
- altitude 11
- applications, downloading 6
- AUTOEXEC.BAT
 - command line parameters 59, 74
 - troubleshooting 74, 78

B

- bulb life 11

C

- cable diagrams
 - RS-232 17
 - RS-422 17
 - RS-485 17
- chemical resistance (faceplate) 13
- Class I, Division II guidelines 50
- cleaning the touch screen 72
- Color STN display 10–11
- Color TFT display 10–11
- COM1 pinouts 15
- COM2
 - jumpers 26, 71
 - pinouts 16
- common problems 72
- Compact Flash
 - slot 22
- CONFIG.SYS
 - command line parameters 75
 - troubleshooting 74, 75
- connecting a serial mouse 18
- connecting to a parallel printer 20
- connecting to a PC 17
- connecting to a serial printer 18

- CPU Manual 2
- CPUs 10
- CRT port 19
- Customer Support Services 7

D

- data storage methods 10
- dimensions 10, 85
- disks
 - See* utility disks
- display types 10
- documentation standards 3
- DOS Shell 43
- download
 - applications 6
 - cable 15–16
 - enable/disable 35
- DRAM
 - picture 66
 - replacement 65
- drive definitions 23

E

- electrical guidelines 51
- electrostatic discharge precautions 63
- enclosure guidelines 51
- environmental guidelines 50
- Ethernet default configuration
 - jumper 24
- Ethernet port
 - configuring 21, 62
 - troubleshooting 80
- expansion modules
 - See* PC/104, modules

F

- faceplate
 - chemical resistance 13
 - cleaning 72

Index

- considerations 50
- rating 11
- fuse type 12

I

- I/O ports 10
- important concepts 5
- input voltage 12
- installation
 - AC power supply 52–53
 - creating the cutout 52
 - mounting the unit 53
 - selecting a location 50
- Interact Project Manager User Guide 2, 6
- IRQs 67

J

- jumpers
 - COM2 26, 71
 - Ethernet default configuration 24, 68
 - touch screen IRQ 25
 - touch screen IRQs 68

K

- keyboard port 21

M

- maintenance
 - See* PowerStation, internal maintenance
- memory
 - addresses 23
 - guidelines 24
 - map 23
 - types 10
- menu definitions
 - Config Settings 34
 - DOS Shell 43
 - Exit Shell 42

- Go To Interact 41
- Help On Shell 33
- System Info 39
- System Tests 43
- Utility Menu 41
- MODE.COM 18
- Monochrome LCD display 10–11
- mouse port
 - See* serial ports, connecting a serial mouse
- mouse, serial 18

O

- operating
 - temperature 11
 - vibration 11

P

- parallel port
 - connecting to a parallel printer 20
 - pinouts 20
- parallel printer 20
- PC/104
 - bus extension 10
 - modules 66
 - power availability 12
- physical specifications 10
- power consumption 12
- power supply (AC) 52–53
- power up 30, 54
- PowerStation
 - connectors 14
 - dimensions 85
 - disassembly 64
 - display types 10
 - documentation set 2
 - drive definitions 23
 - important concepts 5
 - installation 49

- internal maintenance 63
- IRQs 67
- memory map 23
- power up 30, 54
- reassembly 71
- release notes 2
- specifications 10
- template 2
- troubleshooting 72
- User Guide 2
- PowerStation Shell Utility
 - See* Shell
- printer
 - parallel 20
 - serial 18
- PS/2 port
 - See* keyboard port
- R**
 - relative humidity 11
 - replacing DRAM 65
 - RS-232 cable diagram 17
 - RS-422 cable diagram 17
 - RS-485 cable diagram 17
- S**
 - screen calibration 46
 - serial mouse 18, 80
 - serial ports
 - cable diagrams 17
 - COM1 pinouts 15
 - COM2 jumpers 26, 71
 - COM2 pinouts 16
 - connecting a serial mouse 18, 80
 - connecting to a PC 17
 - connecting to a serial printer 18
 - serial printer 18
- Shell
 - Main Menu 32
 - menu definitions 32
 - selecting screen options 30
- Shell Main Menu
 - Config Settings 34
 - DOS Shell 43
 - Exit Shell 42
 - Go To Interact 41
 - Help On Shell 33
 - System Info 39
 - System Tests 43
 - Utility Menu 41
- shock rating 11
- specifications
 - electrical 12
 - environmental 11
 - physical 10
 - testing 13
- STN display 10–11
- T**
 - temperature
 - guidelines 51
 - operating 11
 - TFT display 10–11
 - touch screen
 - calibrating 46
 - cleaning 72
 - jumpers 25, 68
 - troubleshooting
 - AUTOEXEC.BAT 74, 78
 - boot problems 74
 - common problems 72
 - CONFIG.SYS 74, 75
 - Ethernet port 80
 - Interact problems 81
 - keyboard 80
 - serial mouse 80
 - touch screen 78

Index

U

utility disks 4

W

weight 10

Images/P2 Color.bmp @ 130 dpi 1
Images/ctcparlo.wmf 1
Images/ISO Caution.bmp @ 300 dpi 3
Images/ISO Electrical Shock.bmp @ 300 dpi 3
Images/ISO Caution.bmp @ 300 dpi 12
Images/P2 Connectors.bmp @ 125 dpi 14
Images/RS232.bmp @ 150 dpi 17
Images/RS422.bmp @ 150 dpi 17
Images/RS485.bmp @ 150 dpi 17
Images/Download Cable Pinouts.bmp @ 150 dpi 17
Images/Serial Printer Pinouts.bmp @ 150 dpi 19
Images/Memory Map.bmp @ 175 dpi 23
Images/Shell Main Menu.bmp @ 120 dpi 32
Images/Help Menu.bmp @ 120 dpi 33
Images/Download Enable.bmp @ 120 dpi 35
Images/date.bmp @ 120 dpi 36
Images/Set Path.bmp @ 135 dpi 37
Images/touchcal.bmp @ 150 dpi 38
Images/System Information Menu.bmp @ 120 dpi 39
Images/Port Usage.bmp @ 120 dpi 40
Images/Memory Map Display.bmp @ 120 dpi 40
Images/Keyboard Test.bmp @ 120 dpi 43
Images/CF card.bmp @ 200 dpi 44
Images/PCMCIA card.bmp @ 200 dpi 45
Images/touchcal.bmp @ 150 dpi 46
Images/touchcal3.bmp @ 150 dpi 47
Images/ISO Caution.bmp @ 300 dpi 54
Images/CF card.bmp @ 200 dpi 56
Images/PCMCIA card.bmp @ 200 dpi 57
../P3-7/Images/touchcal3.bmp @ 150 dpi 60
../P3-7/Images/InterfaceDOS.bmp @ 150 dpi 61
Images/CPU Card.bmp @ 150 dpi 65
Images/DRAM Module.bmp @ 150 dpi 66

Computer Technology Corporation
50 W. TechneCenter Drive, Milford, Ohio 45150

Phone: 513-831-2340
Technical Support: 513-248-1714

Images/Power Supply Board.bmp @ 150 dpi 68

Images/CPU Card.bmp @ 125 dpi 69

Images/CPU Card.bmp @ 125 dpi 71

Images/CPU Card.bmp @ 150 dpi 76

Images/P2DmenSide.bmp @ 150 dpi 85

Images/P2DmenBack.bmp @ 150 dpi 86