

# **PowerStation RS PC**

## **User Guide**

**CTC Parker Automation**  
**50 W. TechneCenter Drive, Milford, Ohio 45150**

**Phone: 513-831-2340**  
**Technical Support: 513-248-1714**

A3-05729-101

## Copyright and Trademark Notice

Copyright © 1999 by CTC Parker Automation. All rights reserved. No part of this publication may be reproduced, transmitted, transcribed, stored in a retrieval system, in any form or by any means, mechanical, photocopying, recording or otherwise, without the prior written consent of CTC Parker Automation.

While every precaution has been taken in the preparation of this manual, CTC Parker Automation and the author assume no responsibility for errors or omissions. Neither is any liability assumed for damages resulting from the use of the information contained herein. All product and company names are trademarks of their respective companies and licenses.

## Product Warranty Information

CTC Parker Automation provides top quality products through rigid testing and the highest quality control standards. However, should a problem occur with your hardware or with the software protection key, CTC Parker's standard product warranty covers these items for 15 months from the date of shipment from CTC. Exceptions appear below:

- PowerStation RS backlight bulbs have a 90-day warranty.
- Third-party products, such as bus cards, carry the manufacturer's specified warranty.
- For all displays, image retention (burn-in) is not covered by warranty.
- Software revisions that occur within 60 days after purchase are available, under warranty, upon request. Please review the MachineShop License Agreement for additional software warranty information.

Should you have any questions about your application or need technical assistance, please call CTC Parker's Product Technical Support department at 513-248-1714, 8:00 a.m. to 5:00 p.m., Eastern Time. You may call this same number after hours for emergency assistance. See *Customer Support Services* on page 8 of this manual for more information about CTC Parker's support products and services.

# Table of Contents

---

<b>Chapter 1 Manual Overview and Support Services . . . . .</b>	<b>1</b>
Using this Manual . . . . .	2
Documentation Components . . . . .	3
Software Components . . . . .	4
Getting Started . . . . .	6
Unpack the PowerStation RS PC . . . . .	6
Find and Prepare a Location . . . . .	6
Connect the PowerStation RS PC to a Monitor . . . . .	6
Start Up. . . . .	7
Documentation Standards . . . . .	7
ISO Symbols. . . . .	7
Customer Support Services . . . . .	8
Product Technical Support . . . . .	8
Technical Support Products . . . . .	9
Product Support Program. . . . .	9
<b>Chapter 2 Introducing the PowerStation RS PC. . . . .</b>	<b>11</b>
Specifications . . . . .	12
Physical Specifications. . . . .	12
Environmental Specifications . . . . .	12
Electrical Specifications . . . . .	13
Testing Specifications. . . . .	14
Safety Instructions . . . . .	14
Available Connectors . . . . .	16
Serial Ports . . . . .	16
COM1 pinouts . . . . .	17
COM2 and COM3 pinouts . . . . .	17
COM1, COM2, and COM3 cable diagrams . . . . .	18

# Table of Contents

---

Connecting to Another Computer . . . . .	18
Connecting a Serial Mouse . . . . .	19
Connecting to a Serial Printer . . . . .	19
Parallel Port . . . . .	21
Connecting to a parallel printer . . . . .	22
PS/2 Port . . . . .	22
Connecting a keyboard . . . . .	22
Connecting a mouse . . . . .	22
VGA Video Port . . . . .	22
Ethernet Port . . . . .	23
Compact Flash . . . . .	23
<b>Drive Definitions and Memory Map . . . . .</b>	<b>24</b>
RS PC Memory Map . . . . .	27
Memory Guidelines . . . . .	28
Jumper Settings . . . . .	29
Expansion Cards . . . . .	32
Design Issues . . . . .	34
Using a Touchscreen with Interact . . . . .	34
Flash Units vs. Hard Drive Units . . . . .	34
<b>Chapter 3 Installing the RS PC . . . . .</b>	<b>35</b>
Selecting a Location . . . . .	36
Underwriters Laboratories Approval . . . . .	36
Environmental Guidelines . . . . .	36
Electrical Guidelines . . . . .	36
Temperature Guidelines . . . . .	36
Enclosure Guidelines . . . . .	37
Preparing the Location . . . . .	37
Mounting the Unit . . . . .	38

# Table of Contents

---

Connecting to a Monitor . . . . .	39
Connecting to a PowerStation RS Monitor . . . . .	39
Connecting to a non-PowerStation RS Monitor . . . . .	39
Installing the Compact Flash. . . . .	40
Starting Up the RS PC . . . . .	41
<b>Chapter 4 Maintaining and Troubleshooting the RS PC . . . . .</b>	<b>43</b>
Using the Compact Flash Card. . . . .	44
Removing and Replacing the Compact Flash . . . . .	44
Reformatting the Compact Flash . . . . .	45
Configuring the Ethernet Interface . . . . .	50
Installing the CD-ROM Driver . . . . .	52
Preparing for Installation. . . . .	52
Installing the CD-ROM Driver and MSCDEX . . . . .	53
Creating New Files . . . . .	54
Completing the Installation . . . . .	54
Performing Internal Maintenance . . . . .	56
Electrostatic Discharge Precautions. . . . .	56
Cleaning the Fan Filter . . . . .	57
Opening and Closing the PC Cover . . . . .	59
Opening the cover . . . . .	59
Closing the cover . . . . .	60
Removing and Installing DRAM . . . . .	61
Removing a DRAM module . . . . .	61
Installing a DRAM module . . . . .	62
Adding Expansion Cards . . . . .	63
Address Considerations . . . . .	63
IRQ Considerations . . . . .	63

# Table of Contents

---

Changing the Jumper Settings . . . . .	64
Resolving Common Problems . . . . .	69
Resolving Problems When Starting Up . . . . .	70
Resolving Problems After Starting Up . . . . .	75
<b>Appendix A RS PC Dimensional Drawings . . . . .</b>	<b>77</b>
RS PC Bottom View . . . . .	77
RS PC Front View . . . . .	78
RS PC Side View . . . . .	79
<b>Index. . . . .</b>	<b>81</b>

# Manual Overview and Support Services

Thank you for purchasing a PowerStation RS PC. The RS PC is a stand-alone PC designed to be used with CTC Parker's PowerStation RS Monitor. It also can be used with any other industrial monitor.

The RS PC is small — only 15.7" x 7.8" x 8.5" — and can be placed in an enclosure up to 50' from the RS Monitor. Thus, it can be placed closer to existing I/O devices, reducing the amount of wiring to the PC. The RS PC has an open PC architecture that allows you to run CTC Parker's MachineShop software and other programs compatible with MS-DOS® or Windows.® Please take time to review this manual and all other documentation included with the RS PC before operating the unit.

## Chapter Contents

---

<i>Using this Manual</i>	2
<i>Documentation Components</i>	3
<i>Software Components</i>	4
<i>Getting Started</i>	6
<i>Documentation Standards</i>	7
<i>Customer Support Services</i>	8

## Using this Manual

This manual is designed to help you set up and use your PowerStation RS PC. The manual lists the PC's specifications. It also explains how to install the PC and optional components, how to maintain the PC in good condition, and how to solve common problems that may occur in operation. Please read the information presented in this manual before setting up and using your PC.

This manual is divided into the following chapters:

**Chapter 1 — Manual Overview and Support Services:**

Presents an overview of this manual, the other documentation and software provided with the RS PC, and the steps necessary to get your PC up and running. This chapter also includes a description of CTC Parker's customer support services.

**Chapter 2 — Introducing the PowerStation RS PC:** Describes the PC's specifications and the ports available to connect the PC to other devices and to a power source.

**Chapter 3 — Installing the RS PC:** Explains how to install the PC in a control enclosure and how to configure the PC so that it will run your HMI and control software and work with other devices.

**Chapter 4 — Maintaining and Troubleshooting the RS PC:** Explains how to maintain the PC and how to solve problems that may occur in operation.

**Appendix A — RS PC Dimensional Drawings:** Displays dimensional drawings of the PC that will be useful in mounting the PC in an enclosure.



## Documentation Components

The PowerStation RS PC documentation set contains all the information you need to configure, install, and use the PC. The RS PC documentation set includes:

**Release Notes** — This document is provided whenever there is important information about the RS PC that does not appear in this manual. Be sure to read any available Release Notes before installing or operating the PC.

***PowerStation RS PC User Guide*** — This is the document you are reading. It provides detailed information about the RS PC and describes how to configure, install, and use the unit. Please read this manual in its entirety before installing or operating the PC.

**CPU Manual** — This is the manual provided by the manufacturer of the CPU board found in your RS PC. Please familiarize yourself with this manual before operating the unit.

## Software Components

CTC Parker pre-loads each RS PC with the operating system you have requested, Interact and MachineLogic if you have purchased them, and the necessary utilities so that you can run the RS PC immediately upon its arrival at your facility. CTC Parker also provides backup copies of this software on CDs and floppy disks should you need to reinstall it. The table below shows the software that you will receive with your system. A description of each software program and its purpose follows the table.

Disk Name and Part No.	MachineShop Systems			Industrial PC Systems		
	DOS	Windows		DOS	Windows	
		95/98	NT		95/98	NT
MachineShop Installation CD KA-83103	X	X	X		X	X
MachineLogic I/O Configuration CD KA-83104	X	X	X			
MS-DOS 6.22 and Utilities Installation Disk KA-72953	X		X	X		
MS-DOS 6.22 Plus Enhanced Tools B4-04707 (for systems with hard drive)	X		X			
Windows 95/NT VGA Drivers KA-72670		X	X		X	X
Windows NT Emergency Repair Disk KA-72668			X			X
CD-ROM Driver KA-72877 (for systems with CD-ROM drive)	X	X	X	X	X	X

**MachineShop Installation CD KA-83103:** This CD contains program files for the MachineShop Toolbar, the MachineShop Shell, PowerStation touchscreen and network drivers, system files, and utilities. Use this CD if you need to reinstall these files on your development system. See the *MachineShop Installation Booklet* for instructions on how to install the contents of this CD.

**MachineLogic I/O Configuration CD KA-83104:** This CD is shipped only with the MachineShop Development Suite. It contains the drivers you will need to configure your I/O network for MachineLogic, CTC Parker's control software. See the *MachineShop Installation Booklet* for instructions on how to install the contents of this CD.

**MS-DOS 6.22 and Utilities Installation Disk KA-72953:** This disk contains the MS-DOS operating system and utilities. These files have already been installed on your unit, but you can use this disk if you need to reinstall the operating system, or if you need to reformat a Compact Flash card.

**MS-DOS 6.22 Plus Enhanced Tools B4-04707:** This disk is shipped with all RS PCs using a hard drive and running Interact and a Windows operating system (Windows 95, 98, or NT). It contains the MS-DOS 6.22 operating system, which has been installed on your RS PC. It also contains several MS-DOS utilities. Use this disk if you need to reinstall MS-DOS or the utilities included on the disk.

**Windows 95/NT 4.0 VGA Drivers KA-72670:** This disk can be used in RS PCs that run the Windows 95, 98, or NT operating system. The disk contains the Windows VGA drivers to fully support RS PC VGA features. The VGA drivers on this disk have already been installed on your PC and provide better color support than the standard drivers. The Windows 95, 98, and NT VGA drivers exist in separate directories on the disk. Install the files from this disk to the RS PC only if your VGA drivers become corrupted.

**Windows NT Emergency Repair Disk KA-72668:** This disk can be used in RS PCs that use the Windows NT operating system. Use the disk to reboot an NT system whenever the system will not recover from a crash. This disk will allow you to restart the system and repair the corrupted files.

**CD-ROM Driver KA-72877:** If you purchased an RS PC with a CD-ROM drive installed, you will receive this disk. The disk contains the drivers for the CD-ROM drive installed in your PC.

## Getting Started

Now that you have opened the RS PC package, you are ready to unpack the unit, find and prepare a location for the PC, install it, connect it to a monitor, and start up the PC. This section provides a brief overview of these activities. Additional information is available in the remaining chapters of this manual.

### Unpack the PowerStation RS PC

Before you install or operate the RS PC, please complete the following steps:

1. Unpack the RS PC, and verify that you have received all the components you ordered.
2. Fill out the product registration card, and return it to CTC Parker. When you register your unit, you will receive a trial membership in CTC Parker's Product Support Program, which provides complimentary telephone technical support, information on product updates, and service bulletins.
3. Back up the CTC Parker software that came with your unit using the Diskcopy command if you are running MS-DOS, or Windows File Manager/Explorer if you are running Windows.

### Find and Prepare a Location

Once you have unpacked the RS PC and completed the steps in the preceding section, you are ready to find and prepare a permanent location for the PC. Instructions for finding and preparing a location for the PC are included in Chapter 3 of this manual, *Installing the RS PC*.

The PowerStation RS PC is designed to be mounted in a control enclosure. Detailed information about how to do this is included in Chapter 3 of this manual, *Installing the RS PC*.

### Connect the PowerStation RS PC to a Monitor

When you have installed the RS PC in its permanent location, you are ready to connect the PC to a monitor — and perhaps to other devices, such as another computer, a mouse, a keyboard, or a printer. You also can connect the RS PC to a computer network.

Instructions for connecting your RS PC to a monitor are included in Chapter 3 of this manual, *Installing the RS PC*. Information about how to connect the PC to another computer, mouse, keyboard, or printer is included in Chapter 2, *Introducing the PowerStation RS PC*. Information about how to connect the PC to a network is included in Chapter 2, *Introducing the PowerStation RS PC*, and Chapter 4, *Maintaining and Troubleshooting the RS PC*.

## Start Up

After you have mounted the RS PC and connected it to a monitor, you are ready to start up the PC and develop an application or download your HMI projects. Startup instructions are included in Chapter 3 of this manual, *Installing the RS PC*.

## Documentation Standards

As you read this manual, you will notice that the following documentation standards have been followed.

1. Important terms are shown in **bold**.
2. Text to be entered from the keyboard is shown in Courier font.
3. Buttons, menu titles, and keyboard keys are shown in Initial Caps.
4. Indented paragraphs denote one of the following:
  - **Note** - Describes alternative approaches or issues you should be aware of while performing an activity.
  - **Important** - Contains information that you should pay particular attention to while reading the text. Follow this information to save development time and/or minimize problems.
  - **Warning** - Contains information on safety issues. Follow this information to prevent equipment damage or personal injury.

## ISO Symbols



This symbol is the International Standards Organization (ISO) symbol for Caution (ISO 3864 No. B.3.1). This symbol denotes information that could affect operation of the PowerStation RS PC if the information is not properly followed.



This symbol is the ISO symbol for Caution - risk of electrical shock (ISO 3864 No. B.3.6). This symbol denotes information about conditions that could cause personal injury from electrical shock or damage to equipment if the information is not properly followed.

## Customer Support Services

CTC Parker welcomes your thoughts and suggestions on our products and services. You can contact CTC Parker by telephone, email, or fax. You can also visit CTC Parker on the World Wide Web to learn the latest about CTC Parker hardware, software, and customer support services.

Telephone: 513-831-2340

Fax: 513-831-5042

E-mail: sales@ctcusa.com or support@ctcusa.com

World Wide Web: <http://www.ctcusa.com>

CTC Parker recognizes that every customer and every application have different support needs, so CTC Parker offers a variety of support services designed to meet those needs. CTC Parker offers three types of customer support services: Product Technical Support, Technical Support Products, and the Product Support Program (PSP).

## Product Technical Support

The Product Technical Support department welcomes any question that might arise as you develop or run your applications. We offer complimentary support for any customer, whether you are an end-user, original equipment manufacturer (OEM), system integrator, or distributor.

If you have a question about the PowerStation RS PC, be sure to complete the following steps:

1. Check any release notes shipped with the unit. These notes provide important information about the RS PC.
2. Consult the *PowerStation RS PC User Guide* and other printed materials included with the PC.
3. Review Chapter 4 of this manual, *Maintaining and Troubleshooting the RS PC*.

If you cannot find a solution by using one of the above sources, contact CTC Parker's Product Technical Support department at 513-248-1714, 8:00 a.m. to 5:00 p.m., Eastern Time. You may call this same number after hours for emergency assistance.

**Technical Support Products**

Our Technical Support Products department provides service in two areas: training and consulting. CTC Parker offers training on all our products, either at CTC Parker in our state-of-the-art training center or at your site. You can learn how to write custom interfaces, develop specialized applications, and implement your complete, operator interface application. You can contact the Training Coordinator by phone at 1-800-233-3329 or by email at [training@ctcusa.com](mailto:training@ctcusa.com).

CTC Parker offers consulting services through our Professional Consulting Services (PCS) group. Our PCS group can build your application from the ground up by writing custom communications drivers or by designing special modules to perform functions unique to your application. Our team of specialists is flexible, so they can create a project development schedule that meets your needs. You can contact the PCS Coordinator by phone at 1-800-233-3329 or by email at [pcs@ctcusa.com](mailto:pcs@ctcusa.com).

**Product Support Program**

The Product Support Program is designed to keep you up-to-date with current versions of CTC Parker software. The PSP consists of a renewable, one-year membership that provides you with free upgrades, utilities, automatic notification of software updates, and other valuable tools for MachineShop, Interact, and MachineLogic. Single-user, site, and corporate licenses are available. The PSP is an easy, cost-effective way to receive the most recent CTC Parker software and associated utilities. You can contact the PSP Coordinator by phone at 1-800-233-3329 or by email at [psp@ctcusa.com](mailto:psp@ctcusa.com).





# Introducing the PowerStation RS PC

This chapter presents the PowerStation RS PC's specifications and gives instructions for operating the PC safely. It also describes the RS PC's connectors, drive definitions, and memory map. It gives guidelines for adding adapter cards, and it discusses design issues for PCs that use touchscreens and hard drives.

## Chapter Contents

---

<i>Specifications</i>	12
<i>Safety Instructions</i>	14
<i>Available Connectors</i>	16
<i>Drive Definitions and Memory Map</i>	24
<i>Jumper Settings</i>	29
<i>Expansion Cards</i>	32
<i>Design Issues</i>	34

## Specifications

This section describes important specifications for the PowerStation RS PC. Please familiarize yourself with these specifications before operating the PC.

### Physical Specifications

Physical specifications include the RS PC's physical characteristics and compatible hardware devices. This information is shown in the table below.

Category	Specifications
CPUs	5x86 133MHz; Pentium 166 or 200MHz
Memory	5x86 32MB max.; Pentium 64MB max.
Storage	1.44MB high-density floppy disk drive. 2.1GB (min.) hard disk drive (optional). 32X CD-ROM drive (optional). 8, 10, 20, or 40MB compact flash drive (field expandable and replaceable). Actual storage volumes may be higher.
I/O ports	1 9-pin RS232 serial 2 9-pin RS232/422/485 serial configurable 1 25-pin IBM parallel 1 Ethernet 10 base-T
Expansion slots	4 full-size ISA slots available
Dimensions (H x W x D)	8.5" (215.90mm) x 7.8" (198.12mm) x 15.5" (393.70mm)
Weight	13.2 lbs. (6 Kg)

### Environmental Specifications

The RS PC conforms to the environmental specifications listed in the table below.

Category	Specifications
Operating temperature:	5x86 CPUs: 32 to 122°F (0 to 50°C) ambient air temperature at fan inlet Pentium CPUs: 32 to 113°F (0 to 45°C) ambient air temperature at fan inlet
Relative humidity:	10% to 95% non-condensing
Altitude:	-200ft. to 10,000ft. (-60.96m to 3,048m)
Shock rating:	10g peak, 11ms (operating) 30g peak, 11ms (non-operating)
Operating vibration:	0.35mm 10 to 18Hz, 1.0g from 18 to 150Hz

**Important** Limit the RS PC's exposure to adverse conditions such as dust, oil, moisture, condensation, and corrosive vapors to minimize maintenance and repair costs.

Remember that the temperature within a protective enclosure is generally higher than the external temperature. Thus, if the PC is operating inside an enclosure at temperature levels above its rated ambient temperature, you must cool the enclosure.

## Electrical Specifications

The RS PC's electrical specifications appear in the table below.

Category	Unit Specifications
Power supply	90-250 VAC
Power consumption	150 Watts max.
ISA cards	Voltage and current available for expansion cards: 2.5A @ +5V, .25A @ -5V; 1.0A @ +12V, .7A @ -12V

**Important** The PowerStation RS PC's power supply automatically detects the input voltage level and adjusts accordingly. However, always use reliable sources of power and isolate all communication cables from power lines to enhance noise immunity.

If possible, locate the PC away from machinery that produces intense electrical noise (arc welders, etc.). Otherwise, isolate the input power to the PC from the equipment generating electrical noise.

## Testing Specifications

The RS PC conforms to the testing specifications listed below.

Testing Criteria	Classification
Showering arc	NEMA showering arc
Surge withstanding capacitance	IEEE 472-1974
ESD requirements	IEC 801-2
Operating temperature	IEC 68-2-1
Electrical fast transient	IEC 801-4
European Harmonized EAC Standards	EN50082-2, EN55011
Operating vibration	IEC 68-2-6
Mechanical shock	IEC 68-2-27
Random vibration	MIL-STD-810E

## Safety Instructions



The following instructions are intended to help you operate your RS PC safely. Please read them carefully before operating the unit.

**Warning** For safety reasons, the PowerStation RS PC should be opened only by qualified service personnel.

- Disconnect the PC from any power source before cleaning.
- Do not use liquid or spray detergents for cleaning. Use a damp cloth.
- For a pluggable PC, the socket outlet must be installed near the PC and must be easily accessible.
- Keep the PC away from humidity.
- Put the PC on a reliable surface during installation. Dropping it or letting it fall could cause damage.
- The openings on the surface of the PC are for air convection. Protect the PC from overheating. **Do not cover the openings.**
- Make sure that the voltage of the power source is correct before connecting the PC to the power outlet. See *Electrical Specifications* on page 13 of this manual for information about the correct voltage to use with the PC.
- Position the power cord so that people cannot step on it. Do not place anything over the power cord.
- Note all cautions and warnings on the PC.

- If the PC will not be used for a long time, disconnect it from the power source to avoid damage by transient overvoltage.
- Never pour any liquid into an opening in the PC. Doing so could cause fire or electrical shock.
- If one of the following situations arises, have the PC checked by qualified service personnel:
  - a. The power cord or plug is damaged.
  - b. Liquid has penetrated into the unit.
  - c. The PC does not work well, or you cannot get it to work according to the *PowerStation RS PC User Guide*.
  - d. The PC has been dropped and damaged.
  - e. The PC shows obvious signs of breakage.
- Do not leave the PC in an uncontrolled environment where the storage temperature is below -4°F (-20°C) or above 140°F (60°C). Such conditions may damage the PC.
- The sound pressure level at the operator's position, according to IEC 704-1:1982, is equal to or less than 70dB(A).

## Available Connectors

The RS PC has three serial ports (labeled COM 1, COM 2, and COM 3), one parallel port (labeled LPT1), a VGA Video port, an Ethernet port, a Compact Flash connector, and a PS/2 port (labeled Mouse). Use the following illustration of the back of the PC to locate the ports on your PC. The ports and their pinouts are discussed below.

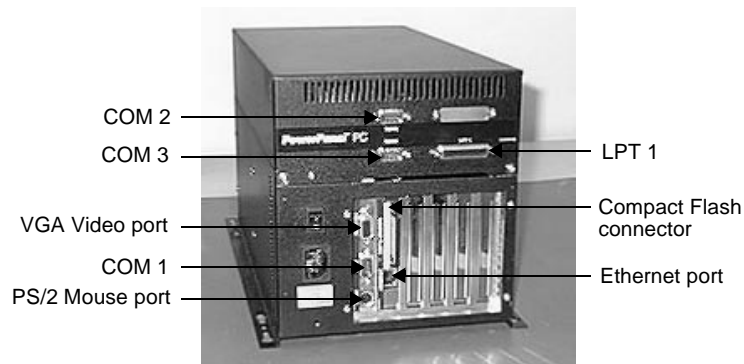

## Serial Ports

The RS PC has three serial ports, COM1, COM2, and COM3, which you can use to communicate with external devices.

These ports support baud rates of up to 115 Kbaud. COM1 supports the RS-232 communication standard. Use a standard DB9 connector for communicating with this port.

The other serial ports, COM2 and COM 3, support RS-232C, RS-422, and RS-485 communication standards. By default, COM2 is set up as RS-232, and COM3 is set up as RS485.

**Note** COM2 on the RS PC is configured, by default, for touch-screen communication with CTC Parker's PowerStation RS Monitor.

The communication standard you select depends upon the distance between the PC and your controller, as well as the communication standards that the controller supports. Use a standard DB9 connector for communicating with these ports.

**Note** If you are using RS-232 communications, the length of the serial cable should not exceed 50 feet (15 meters). RS-422 and RS-485 communications offer greater noise immunity than RS-232. These standards increase the maximum cable length to 4,000 feet (1,200 meters).

RS-422 communications are full-duplex (can send and receive simultaneously), while RS-485 communications are half-duplex (can only send or receive at one time). For either configuration, be careful not to connect any wires to unused connector pins. The pinouts and cable diagrams for the COM1, COM2, and COM3 ports are discussed below.

### COM1 pinouts

If you need to make a cable for communicating with COM1, the table below shows the pinouts and signal information for this port.

Pin #	Signal Name
1	DCD, data carrier detect
2	RXD, received data
3	TXD, transmitted data
4	DTR, data terminal ready
5	Signal ground
6	DSR
7	RTS, request to send
8	CTS, clear to send
9	RI

### COM2 and COM3 pinouts

If you need to make a cable for communicating with COM2 or COM3, the table below shows the pinouts and signal information for this port.

Pin#	RS-232 Signal	RS-422 Signal	RS-485 Signal
1	DCD, data carrier detect	TXD-, transmitted data -	TXD-, transmitted data -
2	RXD, received data	TXD+, transmitted data +	TXD+, transmitted data +
3	TXD, transmitted data	RXD+, received data +	RXD+, received data +
4	DTR, data terminal ready	RXD-, received data -	RXD-, received data -
5	Signal ground	Signal ground	Signal ground
6	DSR, data set ready	DSR, data set ready	DSR, data set ready
7	RTS, request to send	RTS, request to send	RTS, request to send

Pin#	RS-232 Signal	RS-422 Signal	RS-485 Signal
8	CTS, clear to send	CTS, clear to send	CTS, clear to send
9	RI	RI	RI

### COM1, COM2, and COM3 cable diagrams

The graphic below shows the pinouts and cable diagram for communicating with COM1, COM2, and COM3 using the RS-232 protocol. Also shown are cable diagrams for communicating with COM2 and COM3 using the RS-422 and RS-485 protocols.

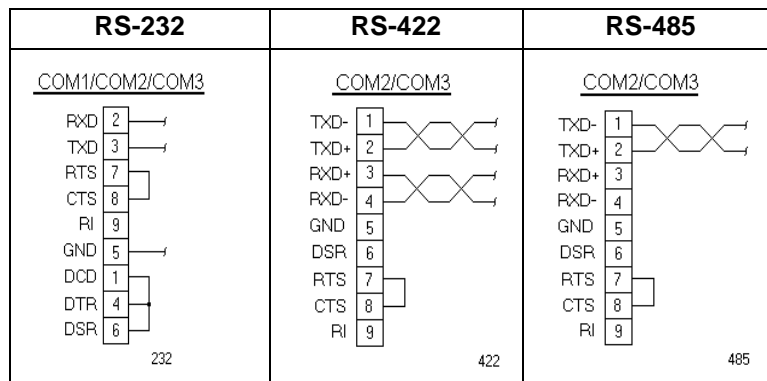

**Important** Be careful not to connect any wires to unused connector pins.

### Connecting to Another Computer

To transfer files to the RS PC from another computer, connect a serial cable with a null modem to an available serial port on the other computer. Connect the other end of the cable to a serial port on the RS PC. If you need to construct your own cables, refer to the figure below.

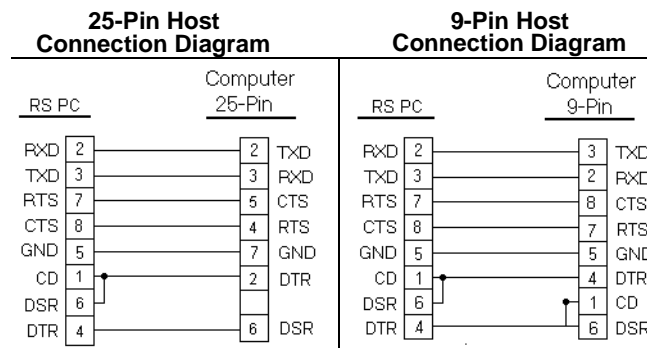



### Connecting a Serial Mouse

If you need to connect a serial mouse to the RS PC, you must use either COM1, COM2, or COM3.

**Note** You may also connect a PS/2 mouse to the RS PC. See *Connecting a mouse* on page 22 for information on how to connect a PS/2 mouse.

Your serial mouse must be connected to a port configured for RS-232 communications. COM1 and COM 2 are already configured for RS-232. However, if you will be connecting your mouse to COM3, you will have to make sure that this port is configured for RS-232 communications.

**To configure the RS PC to use a serial mouse, follow these steps:**

1. If you will be using COM3, verify that the port is configured for RS-232 communications. See *JP8 COM3 serial port configuration* on page 30 of this manual for instructions on how to change the communications protocol for COM3.
2. Connect the serial mouse to COM1, or to the port that you have configured, and restart the PC.

### Connecting to a Serial Printer

If you need to connect the RS PC to a serial printer, you will need to change the mode settings for one of the serial ports to match those of your printer. The easiest way to change these settings is to use the MODE.COM program. MODE.COM can modify the following options:

**baud:** 110, 150, 300, 600, 1200, 2400, 4800, 9600

**parity:** N - none, O - odd, E - even

**databits:** either 7 or 8

**stopbits:** either 1 or 2

CTC Parker installs MODE.COM on the RS PC's Compact Flash card or hard drive. You will make a back-up copy of the file when you create the Powerstation Start Disk from the MachineShop Installation CD shipped with your RS PC. See the *MachineShop Installation Booklet* for instructions on how to create this disk.

**To use MODE.COM, complete the following steps:**

1. From the Windows desktop, open the Startup directory within Interact project:

```
C:\Machshop\Projects\Interact\*Project  
Name*\Startup\
```

2. Within the Startup folder, create a new AUTOEXEC.BAT file with the following line:

```
MODE COM#:baud,parity,databits,stopbits
```

3. Launch the MachineShop Toolbar and download the project that contains AUTOEXEC.BAT and MODE.COM from your development system to the PowerStation.

During the download, MachineShop transfers the AUTOEXEC.BAT file you created in step 3 into the \STARTUP directory specified by the INTERACT\_STARTUP environment variable. This environment variable resides in the PowerStation's AUTOEXEC.BAT file.

When MachineShop finishes the download, you will be asked whether you want to restart the RS PC or not.

4. Restart the RS PC.

MODE.COM will configure the COM port to the required baud rate. For example, if you are communicating at 9600, NONE, 8, and 1, use:

```
MODE COM1: 9600,N,8,1
```

**Note** To print to a port that is configured for downloading, you must disable downloading for that port and re-start the PC. Restarting the PC allows MODE.COM to reset the communication settings for that port. On the Settings menu of the MachineShop Shell, use the Download Enable command to disable downloading.

5. Use the following diagram as a reference when connecting a serial printer to the RS PC.

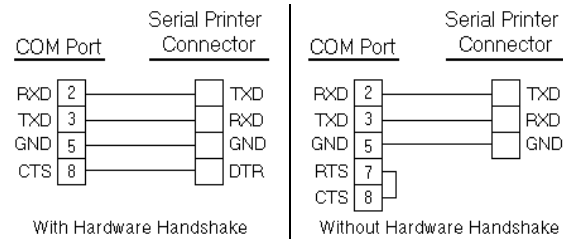

### Parallel Port

The RS PC's parallel port (LPT1) pinout is identical to that of the standard IBM parallel printer port. The LPT1 connector pinout is shown in the table below.

Pin #	Signal Name
1	STROBE
2	DATA 0
3	DATA 1
4	DATA 2
5	DATA 3
6	DATA 4
7	DATA 5
8	DATA 6
9	DATA 7
10	- ACKNOWLEDGE
11	BUSY
12	PAPER EMPTY
13	+ SELECT
14	- AUTO FEED
15	- ERROR
16	- INIT PRINTER
17	- SELECT INPUT
18-25	GROUND

### Connecting to a parallel printer

The RS PC can interface to any parallel printer designed for use with IBM PC-compatible computers. Connect a printer to the LPT1 port at the back of the PC using a standard IBM PC parallel cable.

### PS/2 Port

The RS PC has a PS/2 port located on the CPU board (see the illustration on page 16 of this manual to determine the location of this port). You may use this port to connect a PS/2 mouse and/or keyboard to the unit. See the CPU manual shipped with your RS PC for the PS/2 port's pinout information.

### Connecting a keyboard

The RS PC can receive input from a PS/2 keyboard by connecting the keyboard directly to the PC's PS/2 port. However, if you want to use a keyboard and a mouse simultaneously, you must use the Y-adapter cable shipped with your RS PC.

The Y-adapter cable allows the PC to accept input from a PS/2 mouse and any IBM AT- (but not XT-) compatible keyboard, including 84-key standard keyboards and 101-key enhanced keyboards.

### Connecting a mouse

All RS PCs can receive input from a PS/2 mouse that is connected to the PC by the Y-adapter cable shipped with the PC. You must use the Y-adapter cable because the PS/2 port is configured to receive input from a PS/2 keyboard.

### VGA Video Port

The RS PC has a 15-pin VGA Video port that supports external monitors with resolutions up to 1280 x 1024.

**Note** The maximum resolution of the PowerStation RS 12.1" Monitor is 800 x 600. The maximum resolution of the PowerStation RS 15.1" Monitor is 1024 x 768. Both are supported by the VGA Video port.

**Ethernet Port**

The RS PC has an Ethernet 10 base-T port that allows you to connect the PC to a local area network. This port is software compatible with the NE-2000 protocol and supports all major network operating systems. The Ethernet port pinout is shown in the table below.

Pin#	Signal Name
1	TX+
2	TX-
3	RX+
4	N/C
5	N/C
6	RX-
7	N/C
8	N/C

**Compact Flash**

The PowerStation RS PC has a Compact Flash (CF) connector that accommodates a Compact Flash card. The card, which can be inserted into the connector, is like a removable hard drive that provides non-volatile (i.e., permanent) memory storage. The CF card is often used as a supplement to, or a replacement for, hard drives because it is well-suited for environments in which the PC may be vibrated or shaken.

If no hard drive is present, the CF card is recognized as drive C. If you have a hard drive unit, the CF can be configured as a secondary IDE hard drive. Although the CF card is removable, it cannot be removed or installed while the PC is running because it is used as an IDE drive.

## Drive Definitions and Memory Map

This section provides information about the RS PC's drive definitions, depending upon the type of storage and read/write devices the PC is using. Tables 1 through 5 following show these drive definitions. This section of the manual also includes an illustration of the RS PC's memory map.

**Table 1: Units with Compact Flash**

Drive Letter	Type	Size	Use
C	Compact Flash (CF) Card (Read/Write)	8, 10, 20, or 40MB	System boot drive and project disk. Stores projects, the Machine-Shop Shell, Interact, MachineLogic, system files, and applications. Download files to this drive, but do not log data to this drive unless the size of your CF is sufficient. The CF can only accept a limited number of writes.
A	3.5" Floppy Drive (Read/Write)	1.44MB	Can be used to download projects to the unit, back up files from the unit, and log data.

**Table 2: Units with a Hard Drive**

Drive Letter	Type	Size	Use
C	Hard Disk (Read/Write)	2.1GB or higher	System boot drive and project disk. Stores the necessary system start-up files, the Machine-Shop Shell, Interact, MachineLogic, and applications. Download files and log data to this drive.
A	3.5" Floppy Drive (Read/Write)	1.44MB	Can be used to install software or save files to disk. You can use this drive to download projects to the unit, back up files from the unit, and log data.

**Table 3: Units with Compact Flash and CD-ROM Drive**

Drive Letter	Type	Size	Use
C	Compact Flash (CF) Card (Read/Write)	8, 10, 20, or 40MB	System boot drive and project disk. Stores projects, the MachineShop Shell, Interact, MachineLogic, system files, and applications. Download files to this drive, but do not log data to this drive unless the size of your CF is sufficient. The CF can only accept a limited number of writes.
A	3.5" Floppy Drive (Read/Write)	1.44MB	Can be used to download projects to the unit, back up files from the unit, and log data.
D	CD-ROM Drive (Read only)	N/A	Can be used to read files or run software.

**Table 4: Units with a Hard Drive and CD-ROM Drive**

Drive Letter	Type	Size	Use
C	Hard Drive (Read/Write)	2.1GB or higher	System boot drive and project disk. Stores the necessary system start-up files. This drive also stores projects, the MachineShop Shell, Interact, MachineLogic, and applications. Download files and log data to this drive.
A	3.5" Floppy Drive (Read/Write)	1.44MB	Can be used to install software or save files to disk. You can use this drive to download projects to the unit, back up files from the unit, and log data.
D	CD-ROM Drive (Read only)	N/A	Can be used to read files or run software.

**Table 5: Units with a Hard Drive, Compact Flash, and CD-ROM Drive**

Drive Letter	Type	Size	Use
C	Hard Drive (Read/Write)	2.1 GB or higher	System boot drive and project disk. Stores the necessary system start-up files. This drive also stores projects, the MachineShop Shell, Interact, MachineLogic, system files, and applications. Download files and log data to this drive.
A	3.5" Floppy Drive (Read/Write)	1.44 MB	Can be used to install software or save files to disk. You can use this drive to download projects to the unit, back up files from the unit, and log data.
D	Compact Flash (CF) Card (Read/Write)	8, 10, 20, or 40MB	Secondary drive and project disk. Stores projects, the MachineShop Shell, Interact, MachineLogic, system files, and applications. Download files to this drive, but do not log data to this drive unless the size of your CF is sufficient. The CF can only accept a limited number of writes.
E	CD-ROM Drive (Read only)	N/A	Can be used to read files or run software.



## RS PC Memory Map

The figure below illustrates how the RS PC allocates conventional memory and extended memory. The range of available address references is listed next to each device.

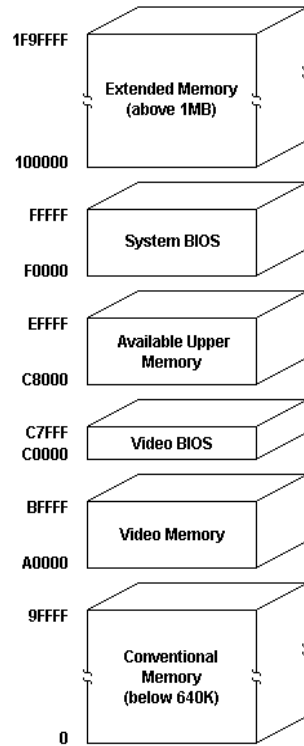

**Memory Guidelines**

If you are using Interact to develop your HMI projects, refer to the table below when you develop projects to run on the RS PC. The table lists guidelines concerning the memory available in the PC for runtime projects.

<b>Memory Type</b>	<b>Capacity and Runtime Use</b>
System DRAM	System memory runs APM, PTM, AND AMM runtime modules and two drivers. A minimum of 4MB of free memory is needed to run a typical Interact runtime application.
Compact Flash	8MB Compact Flash card can store APM, PTM, AMM, and four additional runtime modules, two drivers, and approximately thirty screens. At least 8MB of Compact Flash space is needed to store a typical toolbox application. Extra modules require more storage (four modules/MB). Up to 1MB is needed to store MachineLogic applications. Use for data logging only in conjunction with a hard drive.
Hard Drive	The available 2.1GB hard drive can store applications and logged data.
Floppy Drive	The 1.44MB floppy drive can be used to store logged data.

## Jumper Settings

Like most PCs, the RS PC uses jumpers to set addresses and enable or disable various functions of the system. The RS PC's System Support card has six sets of jumpers for configuring the serial ports, Compact Flash, UCS module, and Ethernet. These jumpers are shown below.

**Note** The UCS module is a personality module manufactured for DeviceNet and Profibus distributed I/O.

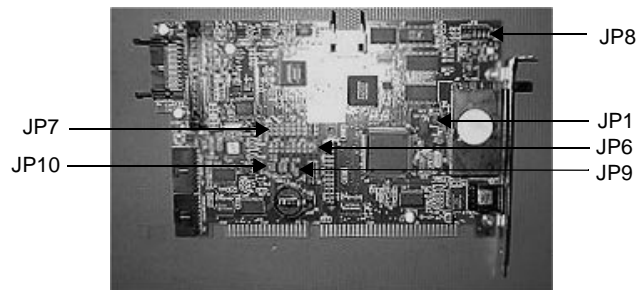

The following sections will describe how the jumpers are set when they are shipped and what they control. In this discussion, jumpers set to “on” and “off” will look like those in the illustration below.

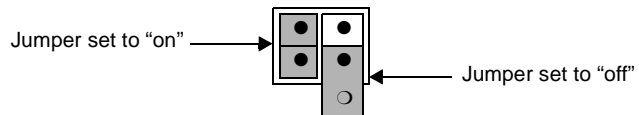

**Note** “Off” jumpers can be completely removed or placed as in the illustration above.

See *Changing the Jumper Settings* on page 64 of this manual for instructions on how to change the jumper settings on your RS PC.

### JP8 COM3 serial port configuration

This set of jumpers, located on the upper right corner of the System Support card, is used to set the serial port configuration. The default setting is the RS-485 communication protocol, but you can configure the jumpers to the RS-232 or RS-422 settings. The figure below shows the default RS-485 setting.

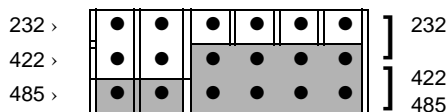

### JP9 serial port address

This set of jumpers configures the address for the JP9 serial port. The address is configured by setting jumpers A and B “on” or “off.” The chart below shows the on/off combinations for each of the ports.

I/O Address	A	B
COM1 (3F8h)	off	off
COM2 (2F8h)	off	on
COM3 (3E8h)	on	off
COM4 (2E8h)	on	on

By default, the JP9 serial port jumpers are set to I/O address COM3 (3E8h) by setting the A jumper “on” and the B jumper “off” as shown below. To configure to the 3F8h address, both the A and B ports would be turned “off.” This setting also is shown below.

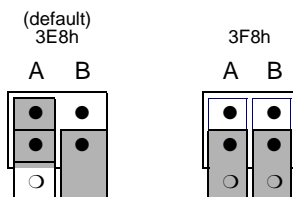

### JP7 serial port IRQ

This set of jumpers is used to configure the hardware IRQ for the serial port. By default, these jumpers are set to serial port = IRQ11 as shown below.

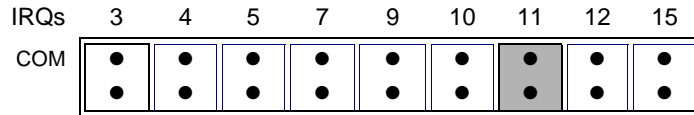

**Important** IRQ 12 is used by the PS/2 port. If you intend to use a keyboard and/or a mouse, do not map to this IRQ.

### JP10 Compact Flash configuration

These jumpers are used to configure the Compact Flash connector. In CF-only units, the Compact Flash is configured as the Primary IDE device, and the IRQ14 setting shown below is used, with the P/S jumper set to “off” and the ENA jumper set to “on.” In hard-drive units, the Compact Flash is configured as the Secondary IDE device (IRQ15), and both jumpers are set to “on.” This setting also is shown below.

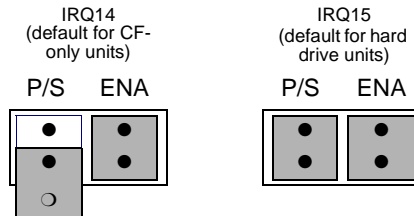

### JP6 UCS module IRQ

This set of jumpers configures the UCS module IRQ. By default, the jumpers are all set to “off” as shown below.

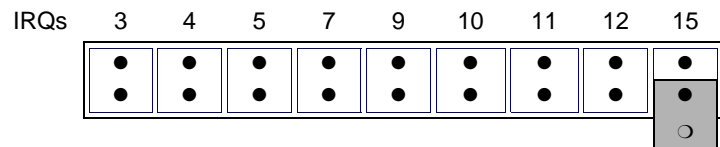

### JP1 Ethernet default jumper

This jumper determines when the Ethernet is configured to its default settings. When the jumper is “on,” the Ethernet is forced to the default settings. When the jumper is “off,” the Ethernet is configured by the software utility. The figure below shows the default “off” setting for the jumper.

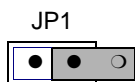

## Expansion Cards

The PowerStation supports ISA-bus expansion cards. See *Adding Expansion Cards* on page 63 of this manual for guidelines about adding expansion cards to the PowerStation.

The table below lists PLC adapter cards that can be used with CTC Parker’s Interact software and the address range for each card when it is used in the PC. Do **not** put all cards at the same location. In all cases, use the highest address location possible. Doing this will provide contiguous memory for applications.

Driver Name	Address Range	Space Required	Memory Boundary
ACCESS4000 (ACC)	C800 - DFFF	2K	Resides on 2K boundaries
Allen-Bradley Remote I/O (ABREMIO)	C800 - DFFF	32K	Resides on 32K boundaries
CTC Parker Automation MachineLogic Control Adapter (MLCA)	C800 - EFFF	4, 8, 16, or 32K	Dependent upon “Space Required”
DCSNET PC Link Module (DCSNET)	A000 - FC00	16K	Resides on 16K boundaries
DeviceNet (DVNT)	C800 - E000	16K	Resides on 16K boundaries
GE Fanuc Genius I/O (GENIUS)	C000 - E000	16K	Resides on 16K boundaries
Giddings & Lewis (GLP9)	C000 - E180	2K	Resides on 2K boundaries
Mitsubishi A7BDE (MITS) - MELSEC-NET and A3N	C800 - DFFF	16K	Resides on 16K boundaries

<b>Driver Name</b>	<b>Address Range</b>	<b>Space Required</b>	<b>Memory Boundary</b>
Mitsubishi A7BDE (MITS) - RS4	C800 - DFFF	8K	Resides on 8K boundaries
Modicon ModBus Plus (MBPL)	C800 - DFFF	2K	Resides on 2K boundaries
OMRON SYSMAC Link (SLNK)	C000 - D800	2K	Resides on 2K boundaries
Opto 22 (MIST)	C000 - E180	2K	Resides on 2K boundaries
Reliance R-NET PC Link Module (RLNT)	C800 - DFFF	16K	Resides on 16K boundaries
Siemens TIWAY (TIWAY)	C000 - E000	4K	Resides on 4K boundaries
Square D SY/MAX Module (SDSL)	CA00 - D300	4K	Resides on 4K boundaries
Sutherland-Schultz SD Adapter (SSSD)	C800 - DFFF	32K	Resides on 32K boundaries
Texas Instruments Remote I/O (TIRIO)	C800 - DFFF	1K	Resides on 1K boundaries

## Design Issues

This section concerns design issues in RS PCs using touchscreens and hard drives. Please read the following sections carefully if you are using a touchscreen with Interact or if you are using an RS PC with a hard drive.

### Using a Touchscreen with Interact

If you are using a touchscreen with Interact, and your application uses PTM Slide input tools, be sure to select the Arrow cursor type using the Interact Settings command in Application Manager. When you select the Arrow cursor type, touching the Slide tool selects the tool, and moving your finger over the touchscreen moves the slide knob.

If you use the Box Cursor type, the slide knob immediately moves to the location where you press the tool. For example, if the knob is currently positioned at 100, and you press the touchscreen at a value of 800, the knob immediately moves to 800 and writes this value to the controller.

**Warning** Using the Box Cursor with a touchscreen and an application that uses Slide input tools may cause you to inadvertently select input values. If your application requires you to use a cursor, select the Arrow cursor type instead.

### Flash Units vs. Hard Drive Units

Some differences between units with Compact Flash and units with hard drives may affect the portability of projects containing startup files between these units.

On hard drive units, the main CONFIG.SYS file (in the root directory of drive C) cannot call a user's CONFIG.SYS file that may be in the Startup directory. In this case, you will need to incorporate the information from the CONFIG.SYS file in the Startup directory into the main CONFIG.SYS file.



## Installing the RS PC

When you have unpacked the PowerStation RS PC, you can begin preparing to install the unit in a permanent location. This chapter gives guidelines for selecting an appropriate location for the RS PC. It also provides instructions for preparing the location and mounting the PC.

### Chapter Contents

---

<i>Selecting a Location</i>	36
<i>Preparing the Location</i>	37
<i>Mounting the Unit</i>	38
<i>Connecting to a Monitor</i>	39
<i>Installing the Compact Flash</i>	40
<i>Starting Up the RS PC</i>	41

## Selecting a Location

The first step in installing the PowerStation RS PC is to select an appropriate location for the unit. This is the most important aspect of the installation because the location you select can affect the PC's performance, ease-of-use, and life-expectancy. This section provides some guidelines to follow when selecting a location for the RS PC.

**Important** The RS PC can be mounted in almost any orientation. However, a CD-ROM drive installed in the RS PC will not operate properly if the PC is mounted upside-down.

## Underwriters Laboratories Approval

In order to obtain Underwriters Laboratories approval for your RS PC installation, the installation must meet the following criteria:

1. The PC must be mounted in a standard industrial enclosure that provides fire protection.
2. The PC must be mounted in an enclosure that meets a NEMA 4 rating.

## Environmental Guidelines

The environment is the area where the RS PC will be located. In general, you should select a place that limits the unit's exposure to adverse conditions such as dust, oil, moisture, and corrosive vapors.

## Electrical Guidelines

To minimize unwanted electrical interference, select a location away from machinery that produces intense electrical noise. If this cannot be avoided, isolate input power to the unit and separate all data communication cables used with the unit from power lines.

See *Electrical Specifications* on page 13 of this manual for a list of electrical specifications for the RS PC. Make sure that your power source is completely compatible with the PC before starting the unit.

## Temperature Guidelines

You can safely operate the RS PC within the temperature range specified in the *Environmental Specifications* on page 12 of this manual. If you are using a protective enclosure, remember that the temperature within an enclosure is generally higher than the external temperature. Thus, if the PC is operating inside an enclosure at temperature levels above its rated ambient temperature, you must cool the enclosure.

**Enclosure Guidelines**

Select an enclosure that is large enough to allow free airflow in and around the unit. You should allow a minimum of 2 inches between the inside of the enclosure and the top and sides of the PC.

Also, make sure that the surface on which the PC will be mounted is flat and free of raised or depressed areas.

**Preparing the Location**

Once you have selected a location, you will need to prepare the drill holes for the RS PC and clean the area of any dirt or debris that may come in contact with the unit.

Dimensions for creating the drill holes for the RS PC are shown in *Appendix A: RS PC Dimensional Drawings (Bottom View)* on page 77. Follow the drill hole dimensions precisely.

**To create the drill holes, follow these steps:**

1. Drill four .39-inch mounting holes as shown in the *RS PC Dimensional Drawings (Bottom View)* on page 77.
2. Debur the drill holes.
3. Ensure that the panel surface is clean and free of foreign materials.
4. Consult the other dimensional drawings in *Appendix A: RS PC Dimensional Drawings* for the depth and port dimensions of your PC. Use these dimensions to customize the mounting of your unit.

## Mounting the Unit

Once the mounting surface has been prepared, you can mount the RS PC. For your convenience, CTC includes all necessary mounting hardware with the unit. To

### To mount the RS PC, follow these steps:

1. Attach the two mounting brackets to the bottom of the PC chassis with the six screws provided. The illustration below shows the brackets fastened to the chassis.

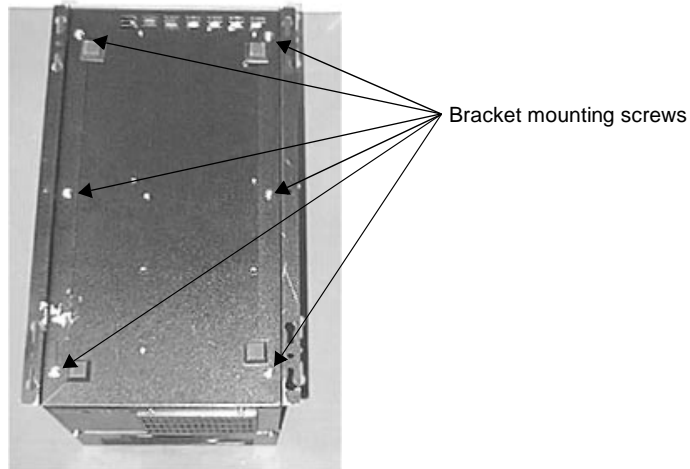

2. Insert the PC mounting screws in the holes prepared for them and partially tighten them. Do **not** tighten the screws all the way down to the surface of the enclosure.
3. Mount the PC by fitting the holes in the mounting brackets over the four mounting screws and sliding the PC forward or back so that the screws slide into the slots in the brackets.
4. Tighten the mounting screws.

## Connecting to a Monitor

Once you have chosen a location for the RS PC and installed the PC, you are ready to connect it to a monitor. This section explains how to connect the PC either to CTC's PowerStation RS Monitor or to another monitor.

### Connecting to a PowerStation RS Monitor

To connect your RS PC to the PowerStation RS Monitor, simply connect the following cables to the appropriate ports at the back of the RS PC:

- Connect the 15-pin video cable between the Analog Video Input port on the RS Monitor and the VGA Video port at the back of the RS PC. The VGA Video Port on the PC is shown in the illustration below.

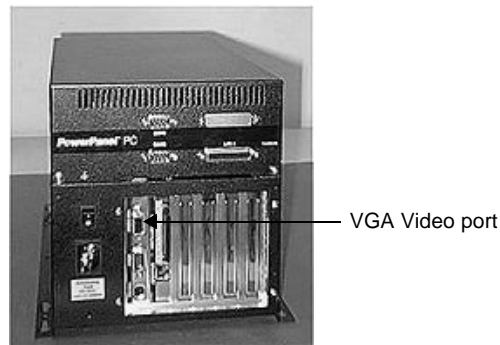

- If you have a touchscreen monitor, connect the 9-pin touchscreen cable between the COM2 port at the back of the RS PC and the 9-pin serial port on the monitor.

### Connecting to a non-PowerStation RS Monitor

To connect your RS PC to a non-PowerStation RS Monitor, simply connect the 15-pin video cable between the VGA Video port at the back of the RS PC and the monitor's video port.

## Installing the Compact Flash

The RS PC accommodates a Compact Flash (CF) card. The card, which can be inserted into the Compact Flash connector at the back of the PC, is like a removable hard drive that provides non-volatile (i.e., permanent) memory storage. The CF card is often used as a supplement to, or a replacement for, hard drives because it is well-suited for environments in which the RS PC may be vibrated or shaken.

### To install the Compact Flash card, follow these steps:

1. Turn off the RS PC.
2. Insert the Compact Flash card into the CF connector as shown below.

**Important** Always make sure that power to the RS PC is turned off when inserting or removing the CF card.

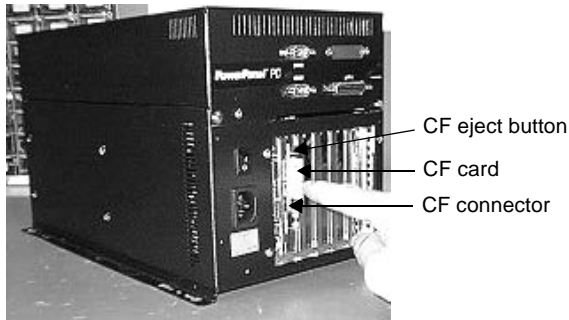

3. Push the card in until it is fully seated. When the card is fully seated, the CF eject button will pop out.

## Starting Up the RS PC



Once the RS PC has been mounted and connected to a monitor, you are ready to start up the unit. The procedure for starting up is described below.

Before connecting power to your RS PC, make sure that you have read and understood the sections on *Electrical Specifications* on page 13 and *Testing Specifications* on page 14 of this manual. Also, make sure that you follow the guidelines listed below:

- For **permanently connected equipment**, a readily accessible disconnect device must be incorporated in the fixed wiring.
- For **pluggable equipment**, the socket-outlet must be installed near the equipment and should be easily accessible.

**Important** Proper installation of the RS PC for use in European Union countries requires the use of a harmonized power cord. (The power cord must be identified with the <HAR> symbol.) Ensure that the PC is connected to the main supply with a harmonized power cord.

1. Verify that the power switch is off. The position of the power switch at the back of the RS PC is shown below.

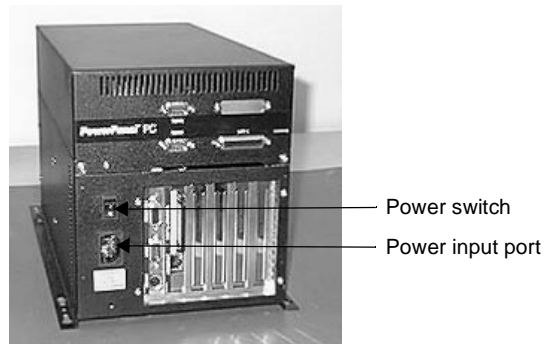

2. Connect the power cord plug to the power input port at the back of the RS PC. The power input port is shown in the preceding illustration.
3. Connect the power cord to your voltage source. Voltage input to the unit should be within the range specified in *Electrical Specifications* on page 13 of this manual.

4. Turn on both the PC and the monitor connected to it.

**Note** The fan on your RS PC should come on, followed immediately by the monitor display.

You are now ready to develop an application or download a project to the RS PC.



# Maintaining and Troubleshooting the RS PC

The PowerStation RS PC has been designed to provide years of trouble-free operation even in the harshest environments. However, occasionally, you may need to perform routine maintenance on some components of the PC's hardware and software.

This chapter provides instructions on using Compact Flash cards, configuring the Internet interface, re-installing the CD-ROM driver, performing internal maintenance tasks, and resolving common problems that may occur in operation.

## Chapter Contents

---

<i>Using the Compact Flash Card</i>	44
<i>Configuring the Ethernet Interface</i>	50
<i>Installing the CD-ROM Driver</i>	52
<i>Performing Internal Maintenance</i>	56
<i>Resolving Common Problems</i>	69

## Using the Compact Flash Card

You will only need to read this section if you are using a Compact Flash (CF) card as the startup and storage drive for your RS PC.

The PowerStation has a slot to accommodate Compact Flash (CF) cards so that you can use a CF card for storage purposes. You can remove the CF card, update the application files on it from a PC, and then reinstall the CF card in the PowerStation.

CTC Parker recommends that you purchase at least one additional CF card to serve as a backup for your primary CF card; you may wish to have several cards to store different projects. You can purchase additional CF cards from CTC Parker.

The remainder of this section explains how to remove and replace the CF card and how to reformat the Compact Flash.

## Removing and Replacing the Compact Flash

**To remove and replace the Compact Flash, complete the following steps:**

1. Turn off the RS PC.

**Important** Always make sure that power to the RS PC is turned off when inserting or removing the CF card.

2. Press the CF eject button as shown below. The CF card will pop out of the CF connector.



3. Remove the CF card from the CF connector as shown below.



4. When you are ready, reinstall the CF card by carefully inserting the card into the connector until it is fully seated. When the card is fully seated, the CF eject button will pop out.

### Reformatting the Compact Flash

This section explains how to create a bootable Compact Flash card for the RS PC from a “blank” CF card. This procedure may be necessary to replace deleted or corrupted critical files on the card or to prepare a new card for use.

You can reformat the CF card either on a PC other than the RS PC or on the RS PC itself.

If you wish to perform this procedure on a computer other than the RS PC, you will need the following equipment:

- A PC with a Type II PCMCIA slot or CF card reader, and a 3.5" floppy drive . The PC should be running MS-DOS 6.22, Windows 95, or Windows 98
- A CF-to-PCMCIA adapter (for use with PCMCIA slot only)
- MS-DOS 6.22 and Utilities Installation Disk (KA-72953)
- PowerStation Start Disk
- MachineShop Shell Installation Disk

**Note** The PowerStation Start Disk and MachineShop Shell Installation Disk make up the Runtime Workstation Disk Set, which you can create from the MachineShop Installation CD shipped with your PowerStation. See the *MachineShop Installation Booklet* for instructions on how to create these disks.

**To reformat the CF card on a PC other than the RS PC, follow these steps:**

1. Turn off the RS PC.

**Important** Make sure that the RS PC is turned off when inserting or removing the CF card.

2. Remove the CF card from the RS PC's CF connector, as described in the preceding section.
3. Insert the CF card into the PC's PCMCIA slot, using the CF-to-PCMCIA adapter or into a CF card reader. The PCMCIA drivers should recognize and configure the card as an ATA card, assigning an additional drive letter for the card (for example, D).

**Note** In this example, drive D represents the PCMCIA card. However, your system may assign a different drive letter to the PCMCIA card.

4. Enter MS-DOS mode.
5. At the DOS prompt, type the following command sequence:

```
FORMAT D:
```

6. Press Enter to execute this command.
7. Insert the MS-DOS 6.22 and Utilities Disk into the PC's floppy drive.

**Important** If you are performing the install procedure in a DOS window under Windows 95 or 98, you must execute the command `LOCK D:` before entering the `INSTALL` command shown below. After the ROM-DOS installation is complete, execute the `UNLOCK D:` command.

8. At the DOS prompt, type the following command sequence:

```
A: INSTALL A: D:
```

9. Press Enter to execute this command.

This will install the MS-DOS system files and utilities onto drive D (or the drive assigned to the CF card).

**Note** You will have two choices when installing DOS: a small installation or a large one. A small installation will install approximately 5 files in the DOS directory. A large installation will install approximately 1MB of files in the DOS directory.

10. Eject the MS-DOS 6.22 Disk from the PC's floppy drive and insert the PowerStation Start Disk.

11. At the DOS prompt, type `A: INSTALL A: D:`

12. Press Enter to execute this command.

You will be asked whether you wish to install the standard CTC AUTOEXEC.BAT and CONFIG.SYS files as part of the installation. CTC recommends that you answer Y for Yes.

If you answer Yes, the existing AUTOEXEC.BAT and CONFIG.SYS files will be renamed as AUTOEXEC.OLD and CONFIG.OLD. If you answer No, the factory-default files will be copied as AUTOEXEC.CTC and CONFIG.CTC in the root directory of drive D, and you will need to manually update your existing AUTOEXEC.BAT and CONFIG.SYS files later.

13. After the AUTOEXEC.BAT and CONFIG.SYS files have been copied onto your system, press any key to continue.

You will be asked if this installation is for a Model P1 PowerStation.

14. Type N for No.

The PowerStation Start installation is complete.

15. Eject the PowerStation Start Disk from the PC's floppy drive and insert the MachineShop Shell Installation Disk.

16. At the DOS prompt, type `A: INSTALL A: D:`

You will be asked if you would like to continue with the installation.

17. Type Y for Yes in order to continue.

The MachineShop Shell installation is complete.

18. Eject the CF-to-PCMCIA adapter and remove the CF from the adapter, or remove the CF card from the card reader.
19. Insert the CF into RS PC's Compact Flash connector.
20. Start up the RS PC.

The RS PC will automatically load the MachineShop Shell.

**Note** If you have connected your RS PC to a PowerStation RS Monitor with touchscreen, you will need to recalibrate the touchscreen when you start the PC with your newly formatted CF card. See the instructions for *Calibrating the Touchscreen* on page 46 in the *PowerStation RS Monitor User Guide*.

**To reformat the CF on the RS PC, follow these steps:**

1. Turn off the RS PC.
2. Insert the MS-DOS 6.22 and Utilities Disk into the floppy disk drive of your RS PC.
3. Restart the RS PC.
4. At the A:\ prompt, type the following:

```
CD\ DOS
```

5. At the next A:\ prompt, type:

```
FORMAT C:
```

**Important** If you are using an RS PC with a hard drive, type  
FORMAT D:

You will be asked if you want to format the C- (or D-) drive (Y/N).

6. Type Y to continue.
7. At the next A:\ prompt, type:

```
INSTALL A: C:
```

**Important** If you are using an RS PC with a hard drive, type  
INSTALL A: D:

You will be asked if you are sure your entry is correct (Y/N).

8. Press **Y** to continue. This will install the MS-DOS 6.22 system files, utilities, and drivers in your \DOS directory.

**Note** You will have two choices when installing DOS: a small installation or a large one. A small installation will install approximately 5 files in the DOS directory. A large installation will install approximately 1MB of files in the DOS directory.

9. Eject the MS-DOS 6.22 disk from the floppy disk drive and insert the PowerStation Start Disk.

10. At the DOS prompt, type the following command sequence:

```
A:INSTALL A: C:
```

**Important** If you are using an RS PC with a hard drive, type

```
A:INSTALL A: D:
```

11. Press **Enter** to execute this command.

This command will install the PowerStation utilities and necessary drivers onto drive C (or the drive assigned to the CF card). You will be asked whether you wish to install the standard CTC AUTOEXEC.BAT and CONFIG.SYS files as part of the installation. CTC recommends that you answer **Yes**.

If you answer **Yes**, the existing AUTOEXEC.BAT and CONFIG.SYS files will be renamed to AUTOEXEC.OLD and CONFIG.OLD. If you answer **No**, the factory-default files will be copied to AUTOEXEC.CTC and CONFIG.CTC in the root directory of drive C (or the drive assigned to the CF card), and you will need to manually update your existing AUTOEXEC.BAT and CONFIG.SYS files later.

12. After the AUTOEXEC.BAT and CONFIG.SYS files have been copied to your system, press any key to continue.

You will be asked if this installation is for a Model P1 PowerStation.

13. Type **N** for **No**.

The PowerStation Start installation is complete.

14. Eject the PowerStation Start Disk from the PC's floppy drive and insert the MachineShop Shell Installation Disk.

15. At the DOS prompt, type `INSTALL A: C:`

**Important** If you are using an RS PC with a hard drive, type  
`A:INSTALL A: D:`

You will be asked if you would like to continue with the installation.

16. Type `Y` for Yes in order to continue.

The MachineShop Shell installation is complete.

17. Restart the RS PC.

The RS PC will automatically load the MachineShop Shell.

**Note** If you have connected your RS PC to a PowerStation RS Monitor with touchscreen, you will need to recalibrate the touchscreen when you start the PC with your newly formatted CF card. See the instructions for *Calibrating the Touchscreen* on page 46 in the *PowerStation RS Monitor User Guide*.

## Configuring the Ethernet Interface

The `\NET` directory of the RS PC's Compact Flash card contains a configuration utility and all drivers necessary to configure the Ethernet interface.



These files are described below.

File Name	Description
AT5CFG.EXE	A configuration utility you can use to change the interrupt and address of the Ethernet interface.
NET.BAT	A sample batch file you can use to run NetBIOS.
NET.CFG	Stores the interrupts and memory for the network drivers. The default PowerStation configuration reserves the following interrupts and I/O addresses. You cannot use these for the Ethernet interface. <ul style="list-style-type: none"> <li>• COM1: Int 4, I/O 3F8</li> <li>• COM2: Int 3, I/O 2F8</li> <li>• Touchscreen: Int 11, I/O 3E8</li> </ul> CTC Parker recommends that you use the following interrupt and I/O address setting for the Ethernet interface: Int 10, I/O 280
NETX.EXE	The Novell Netware shell program that makes the final connection with the server.
*LSL.COM	A Novell driver that enables the workstation to communicate with different protocols.
*IPXODI.COM	A Novell driver that supports the IPX protocol and other protocols over the same network.
*NE2000.COM	A Novell driver that supports the NE2000 protocol. It allows the PowerStation to communicate over a local area network.
*NETBIOS.EXE	Used by Interact to communicate over a network.
RSET8019.EXE	Configures interrupts and I/O addresses for the network.
TCPIP.EXE	Used by the PowerStation for TCP/IP communications.
TCPIP.INI	Stores settings for TCP/IP communications.

\* Denotes files that can be downloaded from Novell's FTP site.

Interact will also communicate over any network or operating system that supports NetBIOS protocols. Examples include Lantastic, Microsoft, and IBM. If you need assistance with NetBIOS and networking, consult your network administrator or a certified network technician.

## Installing the CD-ROM Driver

If you purchased an RS PC with a CD-ROM drive, your CD-ROM drive software will be installed before your PC is shipped. However, if you had to reformat or erase your startup drive, you will need to install the CD-ROM software. This section explains how to perform the installation procedure.

The installation procedure installs the DOS CD-ROM extensions and selected drivers on your system disk. The procedure is described here in four parts: preparing for installation, installing the CD-ROM Driver and MSCDEX files, creating new files, and completing the installation.

### Preparing for Installation

**To prepare for installation, follow these steps:**

1. Turn on the RS PC.
2. If your PC runs a Windows operating system (Windows 95, 98, or NT), click the Windows Start button, click Shut Down, and click Restart the Computer in MS-DOS mode.
3. Insert your CD-ROM Driver disk (KA-72877) in the PC's floppy disk drive.
4. At the A:\ prompt, type `SETUP` and press Enter. You will be asked if you want to install `TAISATAP.SYS`.
5. Type `Y` and press Enter. You will be asked how many CD-ROM drives you have (the default number is 1).
6. Type `1` or the correct number and press Enter.
7. You will be told that:
  - If you want to install the CD-ROM drivers on a bootable floppy disk, you should put the floppy disk in drive B and specify drive B as the drive to copy files to.
  - If you want to install the drivers on a hard disk, you should specify drive C as the drive to copy files to.

**Installing the CD-ROM Driver and MSCDEX**

To install your CD-ROM driver and MSCDEX files, follow these steps:

1. Press Enter when you are ready to continue. You will be asked in which directory you want to install the CD-ROM driver files.
2. Press Enter for drive C (the default drive), or type the appropriate drive letter and press Enter. You will be told that TAISATAP.SYS has been installed in the directory you have designated.
3. Press Enter when you are ready to continue. You will be asked in what directory you would like MSCDEX.EXE to be installed.
4. Press Enter for the default directory (C:/BIN) or type the name of a different directory and press Enter. MSCDEX.EXE will be installed in the directory you indicated.
5. Press Enter when you are ready to proceed. You will be told that:
  - The setup program has copied MSCDEX and the CD-ROM drivers to your system disk.
  - If you continue, the setup program will copy your CONFIG.SYS and AUTOEXEC.BAT files to two new files, called CONFIG.NEW AND AUTOEXEC.NEW.
  - The setup program also will make changes to these .NEW files.
  - When the changes are complete, you will have the choice of either copying these changes into your CONFIG.SYS and AUTOEXEC.BAT files or letting the setup program make the changes for you.

You will then be asked if you want to continue the setup procedure.

6. Type Y if you want to continue and press Enter. The CD-ROM driver and MSCDEX files will be added to your CONFIG.SYS file.

**Creating New Files**

**To create the CONFIG.NEW and AUTOEXEC.NEW files and copy them to your CONFIG.SYS and AUTOEXEC.BAT files, follow these steps:**

1. Press Enter if you want to continue the setup process. The setup program will create the CONFIG.NEW file containing your CONFIG.SYS file and the setup program changes to it.
2. Press Enter. You will be asked if you want to copy the changes from CONFIG.NEW to your CONFIG.SYS file yourself or if you would like the setup program to do this for you.
3. Type Y if you would like the setup program to make the changes and press Enter. The setup program will make the changes to your CONFIG.SYS file and create a backup CONFIG file.
4. Press Enter when you are ready to continue. You will be asked if you are installing MSCDEX on a network server.
5. If you are installing your CD-ROM software on a network server, type Y and press Enter. Follow the instructions and answer the questions you see on the screen.
6. If you are not installing MSCDEX on a network server, type N and press Enter. You will be asked if you want to change the default cache size (the amount of memory your CD-ROM will use). Most CD-ROMs work very effectively with the default size.
7. If you want to change the default cache size, type Y and press Enter. Answer the questions you see on the screen.
8. If you do not want to change the default cache size, type N and press Enter. The setup program will create AUTOEXEC.NEW containing your AUTOEXEC.BAT file and the setup program changes to it.

**Completing the Installation**

**To complete the installation process, follow these steps:**

1. Press Enter when you are ready to continue.
2. You will be asked if you want to make the changes to your AUTOEXEC.BAT file yourself or if you would like the setup program to make these changes for you.
3. Type Y if you would like the setup program to make the changes and press Enter. The setup program will make the

changes to your AUTOEXEC.BAT file and create a backup AUTOEXEC file.

Installation is now complete.

**Important** If your AUTOEXEC.BAT file starts up a shell program, such as Windows or the PowerStation RS PC Shell, you will have to enter AUTOEXEC.BAT after installation is complete to put the line that starts MSCDEX ahead of the line that starts your shell or .BAT file. The line that starts MSCDEX is `C:\DOS\MSCDEX.EXE`. If you do not order the entries in this way, MSCDEX will not be able to start the CD-ROM drive once your shell or .BAT program begins.

4. Press Enter to return to the A:/ prompt.
5. Restart your computer in MS-DOS mode to load the CD-ROM driver and MSCDEX.

**Note** If your PC runs a Windows operating system, restart the computer in Windows (Ctrl + Alt + Delete). Then click the Windows Start button, click Shut Down, and click Restart the Computer in MS-DOS Mode.

## Performing Internal Maintenance

This section includes instructions for performing internal maintenance on the PowerStation RS PC. To prevent injury to yourself and/or damage to the PC, be sure to read and understand the procedures in this section before performing them. This section will show you how to perform the following operations:

- Cleaning the fan filter
- Opening and closing the PC cover
- Removing and installing DRAM
- Changing the jumper settings

First, however, this section describes electrostatic discharge (ESD) precautions that you should take whenever you work inside the RS PC.



**Warning** For safety reasons, the PowerStation RS PC should be opened only by qualified service personnel.

### Electrostatic Discharge Precautions



Modern integrated electronic devices, especially CPUs and memory chips, are extremely sensitive to electrostatic discharges (ESD) and fields. When you perform any internal maintenance procedures on the RS PC, be sure to follow these simple precautions to protect you and the PC from harm resulting from ESD.

- To avoid electric shock, always disconnect power from the RS PC before you open the PC. Do not touch any components of the CPU card or other cards while the PC is on.
- Disconnect power before making any hardware configuration changes. The sudden rush of power as you connect a jumper or install a card may damage sensitive electronic components.
- Only handle internal components in an ESD-safe location, using appropriate grounding methods.
- Wear a grounding wrist strap for continuous protection. Always ground yourself to remove any static charge before you touch the CPU card.
- Be particularly careful not to touch the chip connectors.

- Keep any card or DRAM module in its anti-static packaging when it is not installed in the PC and place it on a static dissipative mat when you are working on it.

### Cleaning the Fan Filter

The fan on the RS PC has a filter, which keeps dirt from getting inside the PC. This filter is located just behind the fan cover on the front of the PC as shown in the illustration under step 1, below. Check this filter frequently to see if it needs to be cleaned or replaced. A spare filter is shipped with the RS PC, and fan filter replacement kits are available from CTC.

**When the fan filter needs to be cleaned, follow these steps:**

1. Remove the two retaining screws located at the bottom of the fan cover as shown below.

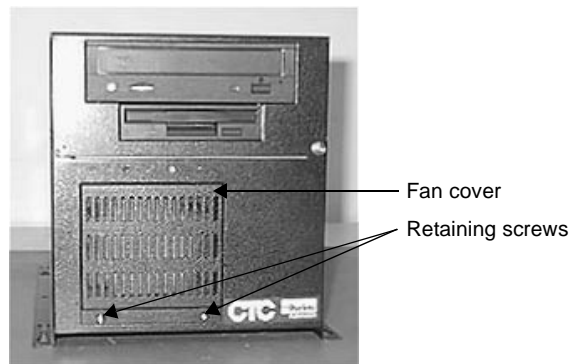

2. Pull the bottom of the fan cover away from the chassis as shown below and slide it downward, off the chassis.

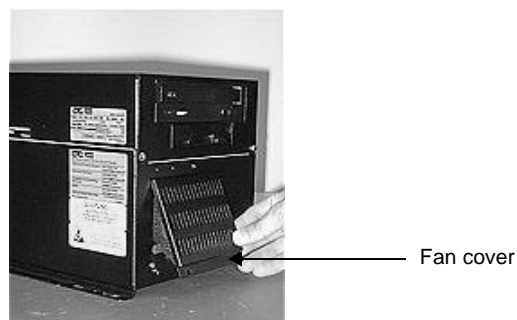

3. Remove the fan filter from the inside of the fan cover as shown below.

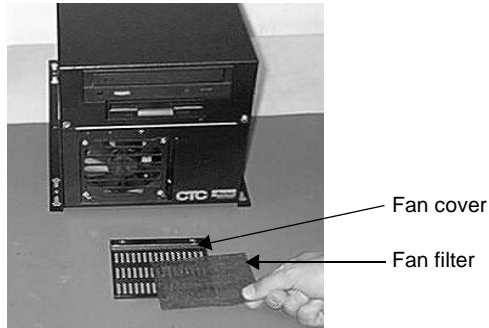

4. Shake or brush the fan filter until it is clean. If necessary, you can wash the filter in warm, soapy water. Be sure to rinse and dry the filter thoroughly before re-installing it.

**Important** The filter must be absolutely dry before you re-install it. For this reason, you may prefer to rotate the two filters you have so that the one you just washed can dry thoroughly before you re-use it.

5. Replace the fan filter in the cover as shown below.

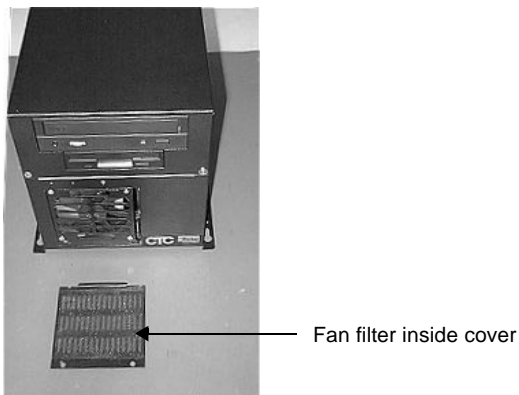

6. Holding the filter in place, slide the flange at the top of the cover into the space for it at the top of the fan opening as shown in the illustration at the top of the next page. Then push the cover into place on the front of the PC.





Fan cover

7. Refasten the fan cover in place with the two retaining screws that you removed in step 1.

### Opening and Closing the PC Cover

Most internal maintenance procedures require that you open and close the cover of the RS PC. Those procedures are described here.

#### Opening the cover

To open the RS PC's cover, follow these steps:

1. Make sure that the PC is turned off and that its power cable is disconnected from the power source.
2. Remove the two retaining screws at the front and back of the PC cover as shown in the two illustrations below.



Front retaining screw



Back retaining screw

3. Lift up the cover and swing it back on its hinges as shown below.

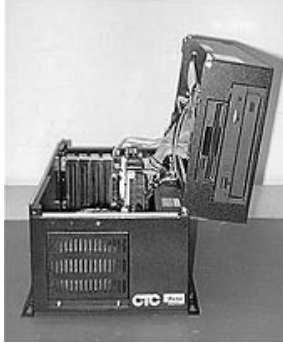

**Note** When you open the cover, a small, triangular, metal “catch” inside the back of the cover will drop down and keep the cover from falling down onto the chassis. This device is shown below.

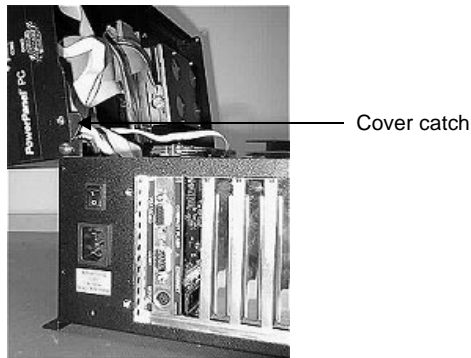

4. Proceed to the specific procedures you need to perform.

### Closing the cover

**To close the RS PC’s cover, follow these steps:**

1. With one hand, lift the catch shown in the preceding illustration and, with the other, lower the cover to its closed position.

**Important** Lower the cover gently. The disk drive(s) mounted inside the cover may be damaged if the cover is allowed to slam shut.

2. Fasten the cover in place with the two retaining screws you removed in step 2 of *Opening the cover* on page 59.
3. Re-attach the PC's power cable to the power source and turn on the PC.

## Removing and Installing DRAM

The RS PC comes with either 8, 16, 32, or 64MB of DRAM installed. Consult the CPU manual shipped with your PC for more information about the size and quantity of DRAM your unit can support.

This section provides instructions on how to remove and install DRAM modules on your CPU card.

### Removing a DRAM module

**To remove a DRAM module from the CPU card, follow these steps:**

1. Make sure that the RS PC is turned off and that it is disconnected from the power source.
2. Open the PC cover (see the procedure for *Opening the cover* on page 59).
3. Locate the CPU Card in the chassis of the PC as shown below. The CPU card is the card that is farthest to the right when viewed from the front of the PC.

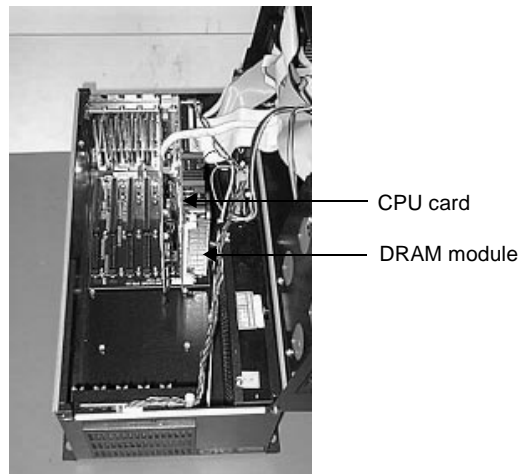

4. Locate the DRAM module (or SIMM) located on the right side of the CPU card as shown in the preceding illustration. The DRAM module is on the end of the CPU card that is closest to you when viewed from the front of the PC.
5. Push outward on the small, metal socket latches at the top and bottom of the module. You may need to use a small screwdriver or the tip of a pen to push on the latches.
6. Turn the DRAM module slightly toward the front of the PC and pull the module out of its socket at an angle.
7. Place the DRAM module in an anti-static bag for storage if you do not plan to reinstall the module at this time.

### Installing a DRAM module

To install a DRAM module in the CPU card, follow these steps:

1. Carefully insert the DRAM module into its socket with the module turned toward the front of the PC at a 45-degree angle.

**Note** Notches at the middle and bottom of the DRAM module, shown in the illustration below, will align with ridges on the socket. Holes at the top and bottom of the module, also shown below, will fit over tabs on the socket.

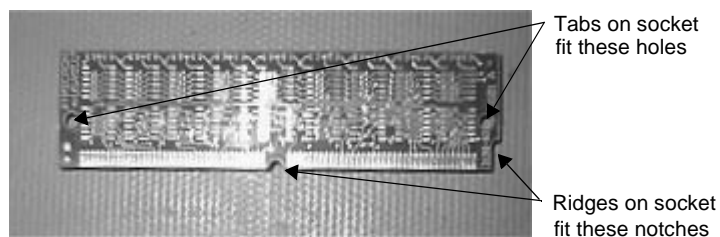

2. Gently, but firmly, push the module into the socket until the socket latches snap into place, securing the module.
3. Close and re-fasten the PC cover (see the procedure for *Closing the Cover* on page 60).
4. Re-connect the PC to its power source.

This completes DRAM installation in your RS PC. The PC will automatically recognize the additional memory.

## Adding Expansion Cards

Many ISA-bus adapter cards are available on the market, and they perform numerous functions. However, the total number of adapter cards you use in the RS PC may not exceed the power supply limits specified for adapter cards in the PC. See *Electrical Specifications* on page 13 of this manual for information about the voltage and current available for expansion cards.

**Note** The RS PC will support Plug-n-Play features if you are running a Windows operating system, but not if you are running DOS. Therefore, when running MS-DOS, keep in mind that adapter cards with Plug-n-Play enabled may not perform correctly and may adversely affect PC operation.

## Address Considerations

As in most ISA-bus computer port addresses, 300 through 31F are available for adapter functions. Address 314 is reserved for use by the RS PC. Make sure that any adapter cards you install do not conflict with this address.

## IRQ Considerations

Interrupt Requests (IRQs) 3, 4, 5, 7, 9, 10, 11, and 15 are available to adapter devices connected to the ISA-bus. The RS PC configures these as shown in the table below.

IRQ	Port
3	COM2
4	COM1
5	
7	
9	
10	Ethernet (software configured)
11	COM3*
15	Compact Flash (if present and configured as secondary IDE)

In the preceding table, the IRQs whose uses are blank are available for use by any adapter card. The Ethernet port is software configured. See *Configuring the Ethernet Interface* on page 50 of this manual for more information about configuration of the Ethernet port.

Those uses marked with an asterisk (\*) in the table may be reconfigured by changing the jumper settings on the RS PC's System Support card. However, changing these jumper settings will require you to change the operating software. You should only make these changes after consulting the CTC Product Technical Support department at 513-248-1714.

### Changing the Jumper Settings

Like most PCs, the RS PC uses jumpers to set addresses for the computer's ports and to enable or disable various computer functions. The RS PC has six sets of jumpers located on the PC's System Support card, which is shown below.

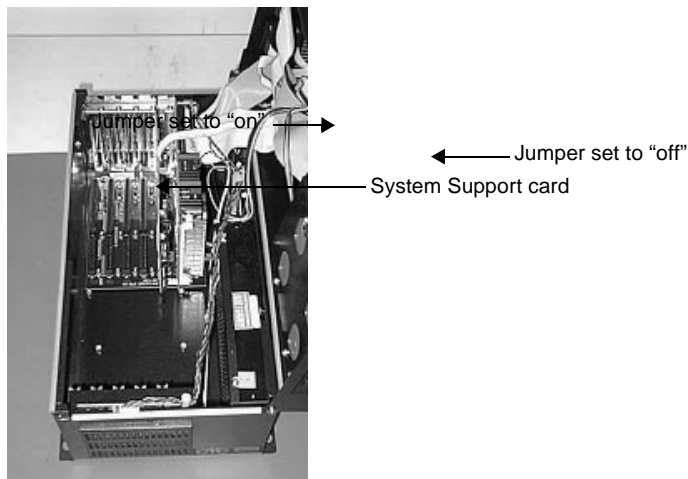

These jumpers, shown below, are used to configure the serial port on the System Support card, the Compact Flash connector, the UCS module, and the Ethernet default.

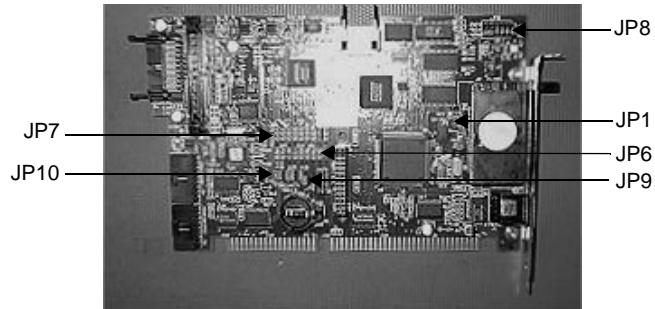

The following sections will describe how these jumpers are set, what they control, and what options you have in configuring your own jumpers. In this discussion, jumpers set to “on” and “off” will look like those in the illustration below

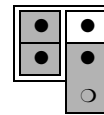

**Note** “Off” jumpers can be completely removed or placed as in the illustration above.

**JP8 COM3 serial port configuration**

This set of jumpers, located on the upper right corner of the System Support card, is used to set the serial port configuration. The default setting is RS-485, but you can configure the jumpers to the RS-232 or the RS-422 protocol.

In the default, RS-485 protocol, the jumpers are set in the positions shown below.

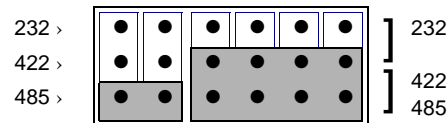

To configure to the RS-422 protocol, set the jumpers in the positions shown below.

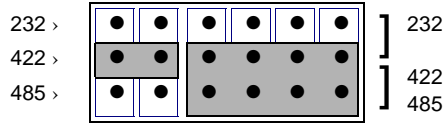

To configure to the RS-232 protocol, place the jumpers in the positions shown below.

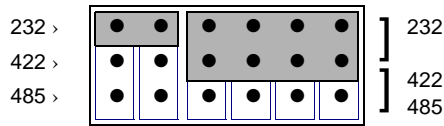

**JP9 serial port address**

This set of jumpers configures the address for the serial port (JP9). Each is configured by setting jumpers A and B “on” or “off.” Use the following table to determine the on/off combination for the address that you would like to configure:

COM1, COM2, COM3, or COM4.

I/O Address	A	B
COM1 (3F8h)	off	off
COM2 (2F8h)	off	on
COM3 (3E8h)	on	off
COM4 (2E8h)	on	on



For example, in the default I/O address COM3 (3E8h), the jumpers are set as shown below, with the A jumper “on” and the B jumper “off.” To map to the COM1 port (3F8h), set both jumpers “off.” This setting also is shown in the illustration below.

**Important** If the port is configured as COM1 (3F8h), COM1 must be disabled in the system BIOS.

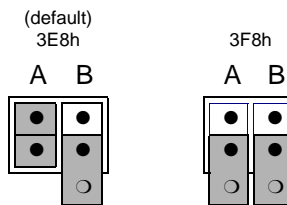

### JP7 serial port IRQ

This set of jumpers is used to configure the hardware IRQ for the serial port. Set the jumpers as shown below to map to the default protocol: serial port = IRQ11. You can map these jumpers to IRQs 3, 4, 5, 7, 9, 10, 11, or 15.

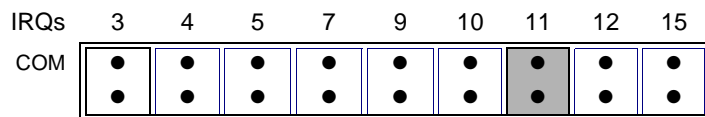

**Important** IRQ 12 is used by the PS/2 port. If you intend to use a keyboard and/or a mouse, do not map to this IRQ.

### JP10 Compact Flash configuration

These jumpers are used to configure the Compact Flash connector. To configure your CF to the Primary IDE adaptor (IRQ14), set the P/S jumper to “off” and the ENA jumper to “on,” as shown in the IRQ14 illustration below.

To configure to the Secondary IDE adaptor (IRQ15), set both jumpers to “on,” as in the IRQ15 illustration below.

Finally, to disable your CF, set the ENA jumper to “off.” Once the ENA jumper is set to “off,” the P/S setting doesn’t matter, so you can set it however you want. In the Disabled illustration below, both jumpers are set to “off.”

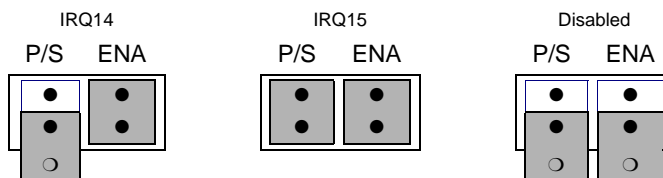

### JP6 UCS module IRQ

This set of jumpers configures the UCS module IRQ. The jumpers are all set to “off” when shipped, as shown below, but you can configure the jumpers to 3, 4, 5, 7, 9, 10, 11, 12, or 15.

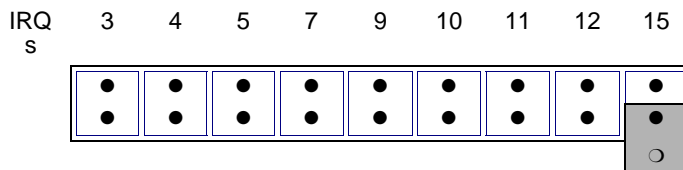

### JP1 Ethernet default jumper

This jumper determines when the Ethernet is configured to its default settings. When the jumper is “on,” the Ethernet is forced to the default settings. When the jumper is “off,” the Ethernet is configured by the software utility. To turn the default settings off, set the jumper to “off” as shown below.

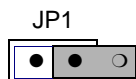

## Resolving Common Problems

This section provides some basic troubleshooting procedures to help you identify and correct problems you may have with the RS PC. Each problem is described, followed by one or more possible solutions. Begin with the first solution and continue until you have solved the problem or tried all of the solutions.

If the problem persists, look through the other problems listed in this section to determine if additional symptoms exist that might require action. If you cannot solve the problem yourself, or if you encounter a problem that is not documented in this section, contact your CTC equipment supplier or the CTC Product Technical Support department at 513-248-1714.

Use the table below to find discussions of specific problems. The problems are divided into two categories:

1. Resolving problems when starting up
2. Resolving problems after starting up

<b>Problem</b>	<b>Page</b>
<b>Resolving Problems When Starting Up</b>	
The fan does not come on, and the display is blank	70
The fan starts, but the display does not	70
The RAM test fails, or the total memory installed does not match the total contiguous RAM listed in the display following the RAM test	71
The RS PC locks up while starting and will not restart	71
Resolving AUTOEXEC.BAT and CONFIG.SYS problems	72
<b>Resolving Problems After Starting Up</b>	
A PS/2 mouse does not work	75
A serial mouse does not work	76
A keyboard does not work	76
The Ethernet port does not work	76

## Resolving Problems When Starting Up

Some of the most common problems that users might encounter with the RS PC will occur when they start up their systems. This section lists some possible solutions for these problems.

### **During startup, the fan does not come on, and the display is blank**

1. Turn off the RS PC.
2. Make sure that the PC is securely plugged into a power source and that the connection between the unit and the power source is complete and firmly attached.
3. Turn on the RS PC. If the fan does not come on, turn off the PC and continue with step 4.
4. Open the cover of the PC (see the procedure for *Opening the Cover* on page 59).
5. Make sure the fan is still securely connected to the power source.

**Note** The fan's connection to the power source runs from the bottom of the fan enclosure inside the front of the PC to the power supply near the right rear of the PC. The connector to check is midway along the wire path.

6. Close and re-fasten the PC's cover (see the procedure for *Closing the cover* on page 60).
7. Reconnect power and turn on the PC.

### **During startup, the fan starts, but the display does not**

1. Make sure that the cables leading from the PC to the monitor are properly connected and secured.
2. Turn off the RS PC.
3. Open the cover of the PC (see the procedure for *Opening the cover* on page 59).
4. Check the installation of the DRAM modules on the CPU board. Make sure that the modules are firmly seated in their sockets and that the socket latches are fully engaged. See *Removing and Installing DRAM* on page 61 for information about the location and proper installation of the DRAM

modules.

**Note** If a DRAM module is not seated properly, the PC will make a beeping sound.

5. Make sure that all cards are firmly seated in the backplane board.
6. Close and fasten the cover of the RS PC (see the procedure for *Closing the cover* on page 60).
7. Turn on the PC.

**The RAM test fails, or the total memory installed does not match the total contiguous RAM listed in the display following the RAM test**

1. Turn off the RS PC.
2. Open the cover of the PC (see the procedure for *Opening the cover* on page 59).
3. Re-seat the DRAM modules on the CPU board. Make sure that the modules are firmly seated in their sockets and that the socket latches are fully engaged. See *Removing and Installing DRAM* on page 61 for information about the location and proper installation of the DRAM modules.
4. Close and re-fasten the RS PC's cover (see the procedure for *Closing the cover* on page 60).
5. Turn on the PC.

**The RS PC locks up while starting and will not restart**

1. Turn off the RS PC.
2. Connect a keyboard to your PC.
3. Turn on the RS PC. When the message "Starting MS-DOS" appears, press the F8 key. This will cause the system to step through the CONFIG.SYS or AUTOEXEC.BAT files line-by-line. If the "Starting MS-DOS" message does not appear, go to step 6.

4. Step through the CONFIG.SYS and AUTOEXEC.BAT files line-by-line until you find the cause of the problem. Remove or correct the offending line in the CONFIG.SYS or AUTOEXEC.BAT file. See *Resolving AUTOEXEC.BAT and CONFIG.SYS problems* on page 72 for information about what the AUTOEXEC.BAT and CONFIG.SYS files should look like.
5. Restart the RS PC to see if the problem has been solved.
6. If the system locks up before the “Starting MS-DOS” message appears, restart the unit and press the Delete key to enter the BIOS setup program.
7. Select the Standard CMOS Setup option or its equivalent and restore the system defaults. This will restore CMOS settings to their factory default configuration.
8. Save these settings and exit the setup program.
9. See the CPU manual that came with your RS PC for more information about using the BIOS setup program.

#### Resolving AUTOEXEC.BAT and CONFIG.SYS problems

Some startup problems are caused by corrupted or modified AUTOEXEC.BAT or CONFIG.SYS files. CTC includes backup copies of these files (AUTOEXEC.CTC and CONFIG.CTC) on the PowerStation RS PC Utilities Disk.

The text for AUTOEXEC.CTC appears below:

```
@ECHO OFF
REM*****
REM PowerStation Autoexec.bat file
REM Copyright (c)1999 CTC Parker Automation
REM*****

PROMPT $p$g
SET TEMP=C:\DOS
PATH C:\;C:\DOS;C:\CTC

REM*****
REM Install PowerStation Special Functions if not running
REM on a P1.
REM*****

C:\TOUCH\IDTOUCH -S
IF ERRORLEVEL 3 GOTO ITSAP1
LH C:\CTC\BIOSTSR
```

```

REM*****
REM If an external mouse is connected, MOUSE will install
REM successfully
REM and create a new MOUSE.INI file.
REM*****

CD \CTC
IF EXIST C:\CTC\MOUSE.INI DEL C:\CTC\MOUSE.INI
LH C:\CTC\MOUSE

:ITSAP1

REM*****
REM Load VESA TSR if not already supported by the video
REM system.
REM*****

C:\CTC\ISVESA
IF NOT ERRORLEVEL 1 GOTO YESVESA
LH C:\CTC\VESA
:YESVESA

REM*****
REM Load the MachineLogic Control Adapter driver if it is
REM present.
REM*****

IF NOT EXIST C:\MACHLOG\NUL.EXT MD C:\MACHLOG
CD \MACHLOG
IF NOT EXIST C:\CTC\MLCA.EXE GOTO NOMLCA
CD \CTC
LH C:\CTC\MLCA

:NOMLCA

REM*****
REM Initialize touchscreen drivers.
REM*****

SET TOUCH_PATH=C:\TOUCH
CALL %TOUCH_PATH%\TCHINIT.BAT

REM*****
REM Set up Interact and MachineLogic environment variables
REM for MS Shell.
REM*****

SET INTERACT=C:\INTERACT
SET INTERACT_FILES=C:\INTERACT\APPFILES
SET INTERACT_STARTUP=C:\STARTUP
SET MACHINELOGIC=C:\MACHLOG

```

```

REM*****
REM Load NETWORK drivers -- NOVELL and/or TCPIP stack.
REM Remove REM on the CALL statement to load NOVELL rem
REM network batch file.
REM If used, this must be called BEFORE loading the TCPIP
REM stack.
REM*****

CD \NET
REM CALL C:\NET\NET.BAT
LH C:\NET\TCPIP

REM*****
REM Load MachineLogic if ML kernel present, and set for
REM boot operation.
REM (determined by MLDU.EXE return value 0 = ENABLED, 1 =
REM DISABLED)
REM*****

IF NOT EXIST C:\MACHLOG\NUL.EXT MD C:\MACHLOG
CD \MACHLOG
IF NOT EXIST C:\MACHLOG\MACHLOG.EXE GOTO NOML
C:\CTC\MLDU
IF ERRORLEVEL 1 GOTO NOML

C:\MACHLOG\RTXDOS
C:\MACHLOG\MACHLOG

:NOML

REM*****
REM Call AUTOEXEC.BAT file contained in project, if it
REM exists.
REM*****

IF NOT EXIST C:\STARTUP\NUL.EXT MD C:\STARTUP
CD \STARTUP
IF EXIST C:\STARTUP\AUTOEXEC.BAT CALL
C:\STARTUP\AUTOEXEC.BAT

REM*****
REM Start the MachineShop Shell.
REM*****

CD \CTC
PSU

```

**The text for CONFIG.CTC appears below:**

```

;MS-DOS V6.22
SHELL=C:\COMMAND.COM /E:1024 /P
FILES=30
DEVICE=C:\DOS\HIMEM.SYS

```



```

REM
REM MachineLogic uses the High Memory Area (HMA) to store
REM all I/O and variable data. Therefore, DOS should be
REM loaded entirely into conventional memory. If
REM MachineLogic is not being used, then DOS should be
REM loaded HIGH into the HMA to conserve conventional
REM memory. To load DOS HIGH use DOS=HIGH,UMB -- otherwise
REM use DOS=LOW,UMB.
REM
REM DOS=HIGH,UMB
DOS=LOW,UMB
REM
REM                                     !!! NOTE !!!
REM If EMM386 is used, any upper (UMB) memory used by
REM adapter cards must be excluded with the "X="
REM parameter, as shown in the example below. This
REM example is for a MachineLogic REM Control Adapter at
REM address D800, configured to use 4KB REM of the factory
REM default). Please adjust the "X=" parameter to match
REM your system configuration.
REM
REM DEVICE=C:\DOS\EMM386.EXE NOEMS X=D800-D8FF
REM
REM On a P1 PowerStation, the range C800 through CFFF must
REM be excluded. Use the following command for loading
REM EMM386 on a P1.
REM
REM DEVICE=C:\DOS\EMM386.EXE NOEMS X=C800-CFFF X=D800-
REM D8FF

```

If you suspect a problem with the AUTOEXEC.BAT or the CONFIG.SYS file of the RS PC, use the DOS Copy command to create a backup copy of your current file. Then overwrite the suspect file with the appropriate backup file. For example, if the AUTOEXEC.BAT file is suspect, type the following commands at the DOS prompt:

```

copy autoexec.bat autoexec.old
copy \ctc\autoexec.ctc autoexec.bat

```

## Resolving Problems After Starting Up

This section lists some possible solutions to problems that may occur after you start up the RS PC.

### A PS/2 mouse does not work

1. Make sure that you are using a Microsoft-compatible PS/2 mouse. Some PS/2 mice that claim to be Microsoft-compatible will not work correctly with the RS PC. Do **not** connect a serial mouse to the PC with a serial-to-PS/2 port adapter.

2. Make sure that you are using the supplied Y-adapter cable to connect the mouse to the PS/2 port. Do **not** plug the mouse directly into the PS/2 port.

**A serial mouse does not work**

See *Connecting a Serial Mouse* on page 19 of this manual for information on how to configure the RS PC to accept a serial mouse.

**A keyboard does not work**

1. Make sure that you are using the supplied Y-adapter cable to connect any IBM AT-compatible keyboard to the PS/2 port.
2. Make sure that the keyboard is an IBM AT keyboard, **not** an XT keyboard.
3. Try using a new Y-adapter cable.
4. Try using a new keyboard.

**The Ethernet port does not work**

1. Make sure that the Ethernet cable is plugged in.
2. Check the AUTOEXEC.BAT file to make sure that your networking software is being loaded.

**Note** The entry in the AUTOEXEC.BAT file that loads the networking software will depend upon the type of networking software you are using.

See *Resolving AUTOEXEC.BAT and CONFIG.SYS problems* on page 72 of this manual for information about what the AUTOEXEC.BAT and CONFIG.SYS files should look like.

3. Make sure that you have properly configured the networking software. See *Configuring the Ethernet Interface* on page 50 of this manual for instructions on how to configure the network software.

# RS PC Dimensional Drawings

## RS PC Bottom View

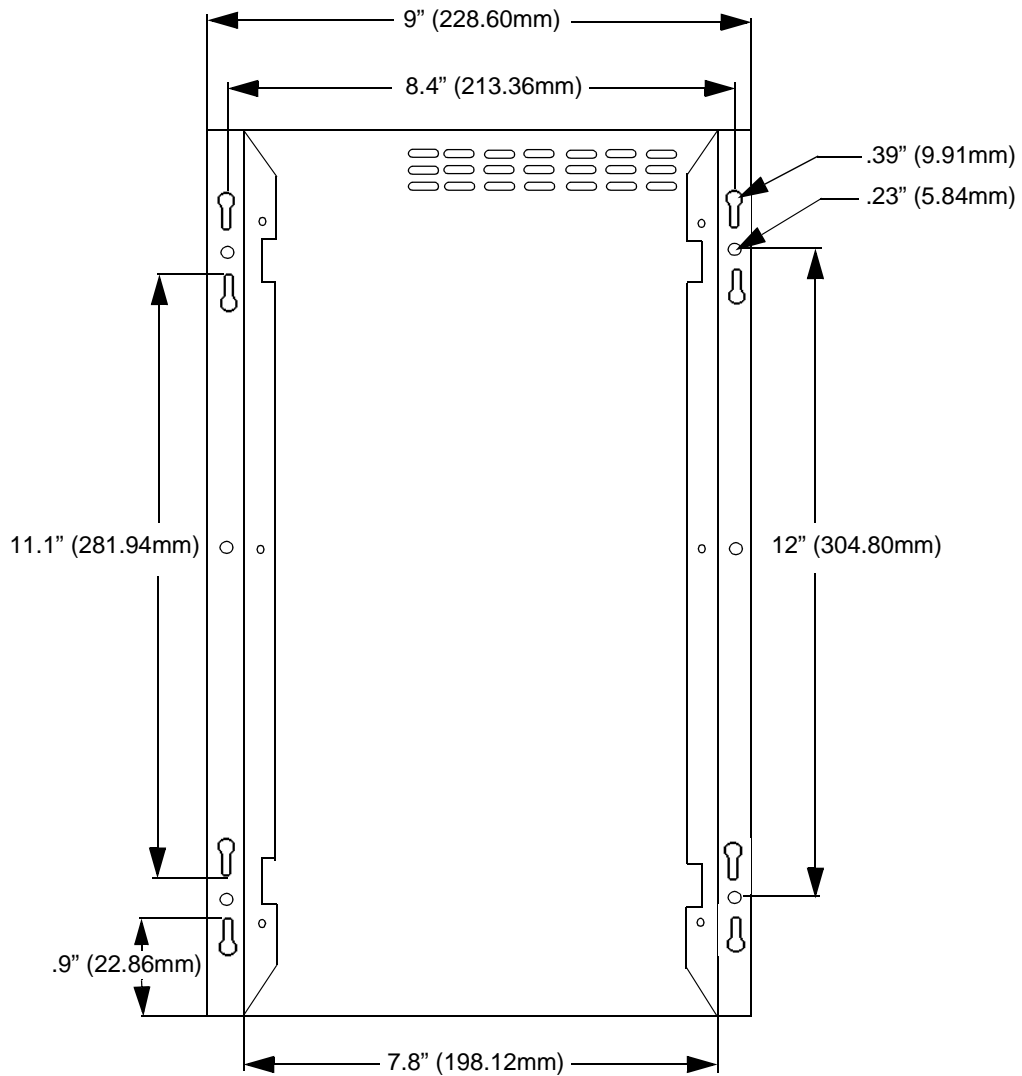

## RS PC Front View

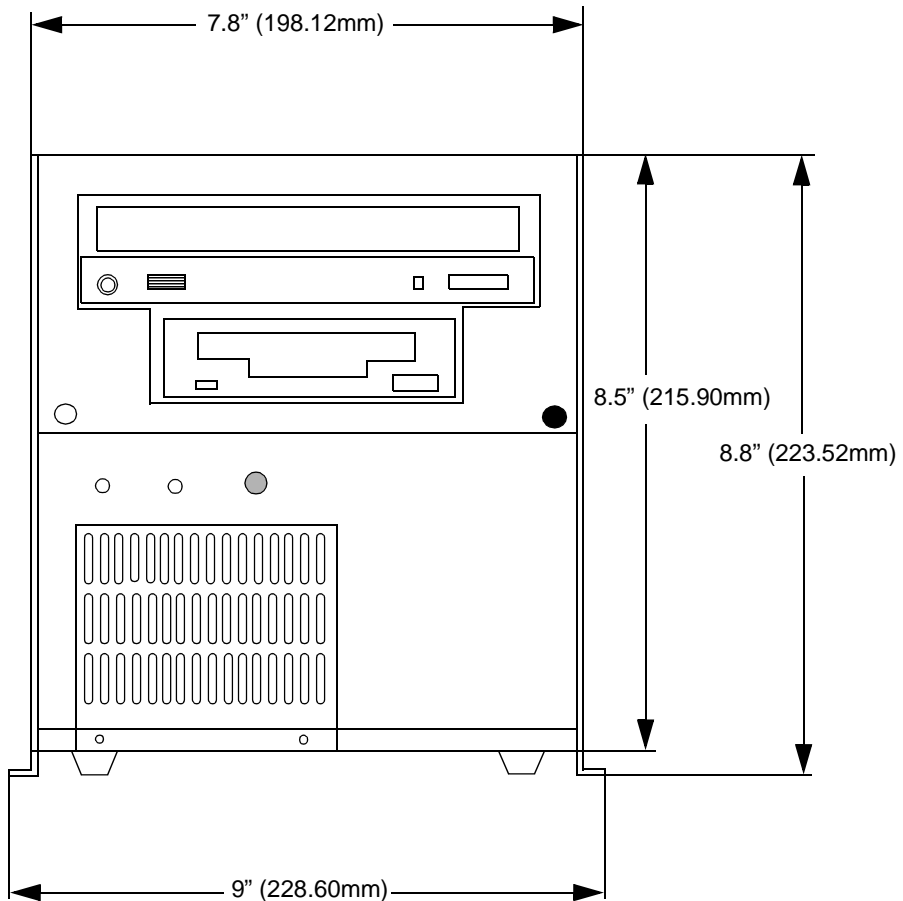

## RS PC Side View

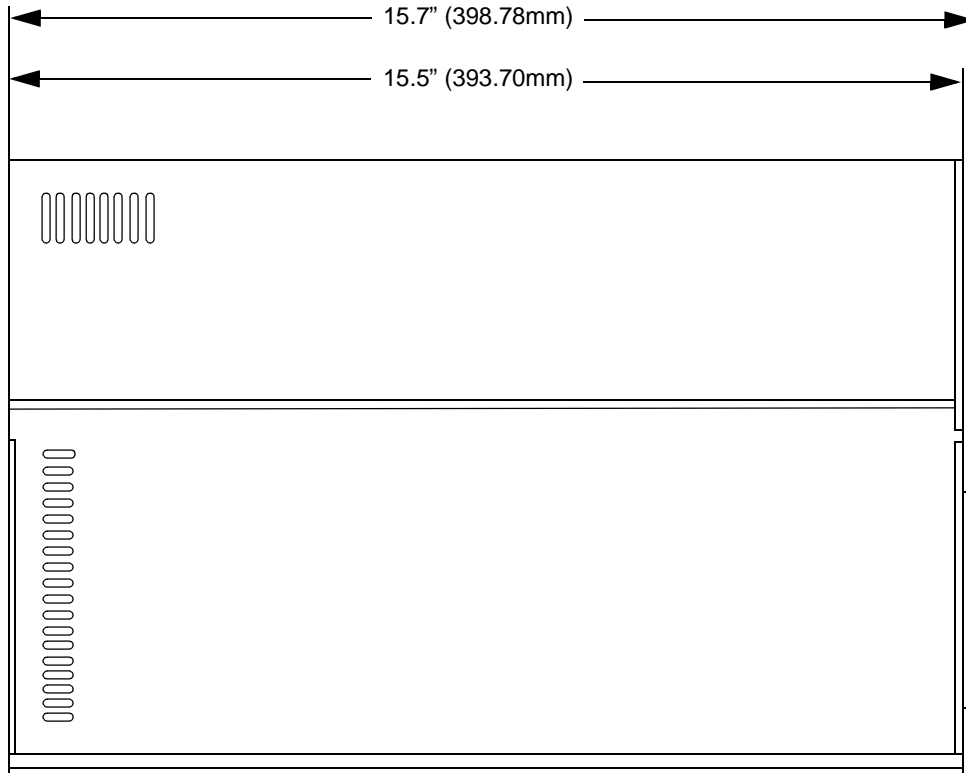



## A

- adapter cards. See PowerStation RS PC
- adding adapter cards
- AUTOEXEC.BAT
  - resolving AUTOEXEC.BAT and CONFIG.SYS problems 72–75

## C

- cable diagrams 18
- CD-ROM drive
  - installing the CD-ROM driver 52–55
- COM1 pinouts 17
- COM2 pinouts 17
- COM3 pinouts 17
- common problems
  - Ethernet port does not work 76
  - keyboard does not work 76
  - PS/2 mouse does not work 75–76
  - resolving AUTOEXEC.BAT and CONFIG.SYS problems 72–75
  - resolving problems after starting up 75–76
  - resolving problems when starting up 70–75
- Compact Flash 16, 23, 24, 25, 26, 28, 31, 34, 40, 45–50, 63, 65, 67
  - installing the Compact Flash 40
  - jumpers 31, 67
- Compact Flash 45
- CONFIG.SYS
  - command line parameters 74
  - resolving AUTOEXEC.BAT and CONFIG.SYS problems 72–75
- connectors
  - Compact Flash 23
  - connecting a PS/2 mouse 22
  - connecting to a parallel printer 22
  - connecting to a serial printer 19–21
  - connecting to another computer 18

- Ethernet port 23
- parallel port 21
- PS/2 port 22
- serial mouse 19
- serial ports 16–18
- VGA video port 22
- CPU Manual 3
- Customer Support Services
  - Product Support Program 9
  - Product Technical Support 8
  - Technical Support Products 9

## D

- design issues
  - Flash units vs. hard drive units 34
  - using a touchscreen with Interact 34
- documentation standards 7
- DRAM
  - removing and installing 61–62
- drive definitions 24–26

## E

- electrical guidelines 36
- electrostatic discharge (ESD) precautions 56
- enclosure guidelines 37
- environmental guidelines 36
- Ethernet interface
  - configuring the Ethernet interface 50
- Ethernet port
  - jumpers 32

## G

- getting started 6–7

## I

- installation
  - connecting to a monitor 39
  - mounting the unit 38

# Index

---

- selecting a location 36
  - starting up 41–42
  - Interact 4, 9, 24, 25, 26, 28, 32, 34, 51, 73
  - IRQs 31, 63, 67
  - ISA-bus expansion cards 32
  - ISO symbols 7
- J**
- jumpers
    - changing jumper settings 64–68
    - Compact Flash configuration 31, 67
    - Ethernet default settings 32, 68
    - jumper settings 29–32
    - serial port address 30, 66
    - serial port configuration 30, 65
    - serial port IRQ 31, 67
    - UCS module IRQ 31, 68
- K**
- keyboard
    - connecting a keyboard 22
- M**
- MachineLogic 4, 5, 9, 24, 25, 26, 32, 73, 75
  - MachineShop 1, 4, 5, 9, 19, 20
    - Installation CD 4, 19
    - MachineShop Shell 4, 24, 25, 26, 47, 48, 50, 74
    - MachineShop Shell Installation disk 47, 49
    - toolbar 4
  - maintenance
    - changing jumper settings 64–68
    - cleaning the fan filter 57–59
    - opening and closing the PC cover 59–61
    - removing and installing DRAM 61–62
  - memory
    - guidelines 28
    - memory map 27
    - types 12
  - mouse
    - PS/2 22
    - serial 19
  - MS-DOS 1, 4, 5, 6, 45, 46, 47, 48, 49, 52, 55, 63, 71, 72, 74, 75
- N**
- NEMA 36
- P**
- parallel port
    - connecting to a parallel printer 22
  - PowerStation RS Monitor 1, 16, 39, 48, 50
  - PowerStation RS PC
    - adding adapter cards 32–33, 63–64
    - cable diagrams 18
    - common problems 69–76
    - Compact Flash connector 23
    - connecting a keyboard 22
    - connecting a PS/2 mouse 22
    - connecting a serial mouse 19
    - connecting to a parallel printer 22
    - connecting to a serial printer 19–21
    - connecting to another computer 18
    - connectors 16–23
    - CPUs available 12
    - dimensional drawings 77–79
    - dimensions 12
    - documentation set 3
    - drive definitions 24–26
    - Ethernet port 23
    - expansion slots 12
    - getting started 6–7
    - I/O ports 12



- internal maintenance 56–68
- IRQs 31, 63, 67
- jumper settings 29–??
- memory map 27
- parallel port 21
- power consumption 13
- power supply 13
- PS/2 port 22
- Release Notes 3
- serial ports 16–18
- software components 4
- specifications 12–14
- starting up 41–42
- storage devices 12
- unpacking 6
- User Guide 3
- VGA video port 22
- weight 12
- printer
  - parallel 22
  - serial 19–21
- PS/2 mouse 22, 75–76
- PS/2 port
  - connecting a keyboard 22
  - connecting a mouse 22

## R

- reformatting the Compact Flash 45, ??–50
- RS-232 cable diagram 18
- RS-422 cable diagram 18
- RS-485 cable diagram 18

## S

- serial ports
  - cable diagrams 18
  - COM1 pinouts 17
  - COM2 pinouts 17
  - COM3 pinouts 17
  - jumpers 30–31, 65, 67
- Source CD(s) 4
- specifications
  - electrical 13
  - environmental 12–13
  - physical 12
  - testing 14

## T

- temperature guidelines 36
- troubleshooting. *See* common problems

## U

- Underwriters Laboratories approval 36

# Index

---